

ASIGURAREA INFRASTRUCTURII PENTRU TRANSPORTUL VERDE – PISTĂ DE BICICLETE ÎN COMUNA LIMANU, JUDEȚUL CONSTANȚA



B. PĂRȚILE DESENAȚE EXEMPLAR 1

Beneficiar: COMUNA LIMANU

Proiectant: S.C. 1ENGINEERING S.R.L.

Faza: PROIECT TEHNIC ȘI DETALII DE EXECUȚIE

1	PLAN DE ÎNCADRARE	P.0A	1:5000
2	PLAN SITUATIE EXISTENTA	Pe.01	1:1000
3	PLAN SITUATIE EXISTENTA	Pe.02	1:1000
4	PLAN SITUATIE EXISTENTA	Pe.03	1:1000
5	PLAN SITUATIE EXISTENTA	Pe.04	1:1000
6	PLAN SITUATIE EXISTENTA	Pe.05	1:1000
7	PLAN SITUATIE PROPUSA	Ps.01	1:500
8	PLAN SITUATIE PROPUSA	Ps.02	1:500
9	PLAN SITUATIE PROPUSA	Ps.03	1:500
10	PLAN SITUATIE PROPUSA	Ps.04	1:500
11	PLAN SITUATIE PROPUSA	Ps.05	1:500
12	PLAN SITUATIE PROPUSA	Ps.06	1:500
13	PLAN SITUATIE PROPUSA	Ps.07	1:500
14	PLAN SITUATIE PROPUSA	Ps.08	1:500
15	PLAN SITUATIE PROPUSA	Ps.09	1:500
16	PLAN SITUATIE PROPUSA	Ps.10	1:500
17	PROFIL LONGITUDINAL PISTA BICICLETE DREAPTA - TRASEU DUS	L1.01	1:500/1:100
18	PROFIL LONGITUDINAL PISTA BICICLETE DREAPTA - TRASEU DUS	L1.02	1:500/1:100
19	PROFIL LONGITUDINAL PISTA BICICLETE DREAPTA - TRASEU DUS	L1.03	1:500/1:100
20	PROFIL LONGITUDINAL PISTA BICICLETE DREAPTA - TRASEU DUS	L1.04	1:500/1:100
21	PROFIL LONGITUDINAL PISTA BICICLETE DREAPTA - TRASEU DUS	L1.05	1:500/1:100
22	PROFIL LONGITUDINAL PISTA BICICLETE STANGA - TRASEU INTORS	L2.01	1:500/1:100
23	PROFIL LONGITUDINAL PISTA BICICLETE STANGA - TRASEU INTORS	L2.02	1:500/1:100
24	PROFIL LONGITUDINAL PISTA BICICLETE STANGA - TRASEU INTORS	L2.03	1:500/1:100
25	PROFIL LONGITUDINAL PISTA BICICLETE STANGA - TRASEU INTORS	L2.04	1:500/1:100
26	PROFIL LONGITUDINAL PISTA BICICLETE STANGA - TRASEU INTORS	L2.05	1:500/1:100
27	PROFILE TRANSVERSALE TIP/STRUCTURA RUTIERA	PTip-01	1:50
28	PROFILE TRANSVERSALE TIP/STRUCTURA RUTIERA	PTip-02	1:50
29	PROFILE TRANSVERSALE TIP/STRUCTURA RUTIERA	PTip-03	1:50
30	PROFILE TRANSVERSALE TIP/STRUCTURA RUTIERA	PTip-04	1:50
31	SECTIUNI TRANSVERSALE DC8 PISTA BICICLETE - TRASEU DUS - INTORS	T.01	1:100
32	SECTIUNI TRANSVERSALE DC8 PISTA BICICLETE - TRASEU DUS - INTORS	T.02	1:100
33	SECTIUNI TRANSVERSALE DC8 PISTA BICICLETE - TRASEU DUS - INTORS	T.03	1:100
34	SECTIUNI TRANSVERSALE DC8 PISTA BICICLETE - TRASEU DUS - INTORS	T.04	1:100
35	SECTIUNI TRANSVERSALE DC8 PISTA BICICLETE - TRASEU DUS - INTORS	T.05	1:100
36	SECTIUNI TRANSVERSALE DC8 PISTA BICICLETE - TRASEU DUS - INTORS	T.06	1:100
37	SECTIUNI TRANSVERSALE DC8 PISTA BICICLETE - TRASEU DUS - INTORS	T.07	1:100
38	SECTIUNI TRANSVERSALE DC8 PISTA BICICLETE - TRASEU DUS - INTORS	T.08	1:100
39	SECTIUNI TRANSVERSALE DC8 PISTA BICICLETE - TRASEU DUS - INTORS	T.09	1:100
40	SECTIUNI TRANSVERSALE DC8 PISTA BICICLETE - TRASEU DUS - INTORS	T.10	1:100
41	SECTIUNI TRANSVERSALE DC8 PISTA BICICLETE - TRASEU DUS - INTORS	T.11	1:100
42	SECTIUNI TRANSVERSALE DC8 PISTA BICICLETE - TRASEU DUS - INTORS	T.12	1:100
43	SECTIUNI TRANSVERSALE DC8 PISTA BICICLETE - TRASEU DUS - INTORS	T.13	1:100
44	DETALIU COFRAJ ZID DE SPRIJIN TIP "L" H = 1,35 m	Zid1.01	1:50
45	DETALIU ARMARE ZID DE SPRIJIN TIP "L" H = 1,35 m	Zid1.02	1:50
46	DETALIU COFRAJ ZID DE SPRIJIN TIP "L" H = 1,00 m	Zid2.01	1:50
47	DETALIU ARMARE ZID DE SPRIJIN TIP "L" H = 1,00 m	Zid2.02	1:50
48	DETALIU PISTA BICICLETE ACCESURI PROPRIETATI	D.01	1:20/ 1:50
49	DETALIU AMPLASARE 2xTEAVA 110x3.2 mm	D.02	1:20/ 1:50
50	DETALIU RIGOLA CAROSABILA ACCES PROPRIETATI	D.03	1:50
51	DETALIU COFRAJ SI ARMARE CAMERA DE CADERE NR. 1	C.01	1:50
52	DETALIU COFRAJ SI ARMARE CAMERA DE CADERE NR. 2	C.02	1:50



Pista biciclete - traseu dus
DC8 km 1+642 - km 3+338 dr.
(lungime 1696 m)

Pista biciclete - traseu intors
DC8 km 1+642 - km 3+293 stg.
(lungime 1651 m)



Verificator	Nume	Semnatura	Cerinta	Referat nr./data
Proiectant:	1ENGINEERING		Beneficiar	Proiect nr. 241/2024
1ENGINEERING SRL • RO28725629 • J13/1567/2011 • CONSTANTA, B-DUL TOMIS, NR.143A			COMUNA LIMANU, JUDEȚUL CONSTANȚA	
Sef proiect	ing.Sorin PANA		Scara 1:5000	Faza: P.T.+D.E.
Proiectat	ing.Andreea ANTOHI		Data APRILIE 2024	Plansa nr. P.0A
Verificat	ing.Sorin PANA			

ASIGURAREA INFRASTRUCTURII PENTRU TRANSPORT VERDE - PISTA DE BICICLETE IN COMUNA LIMANU, JUDEȚUL CONSTANTA

PLAN DE AMPLASARE IN ZONA TRASEE PISTE BICICLETE

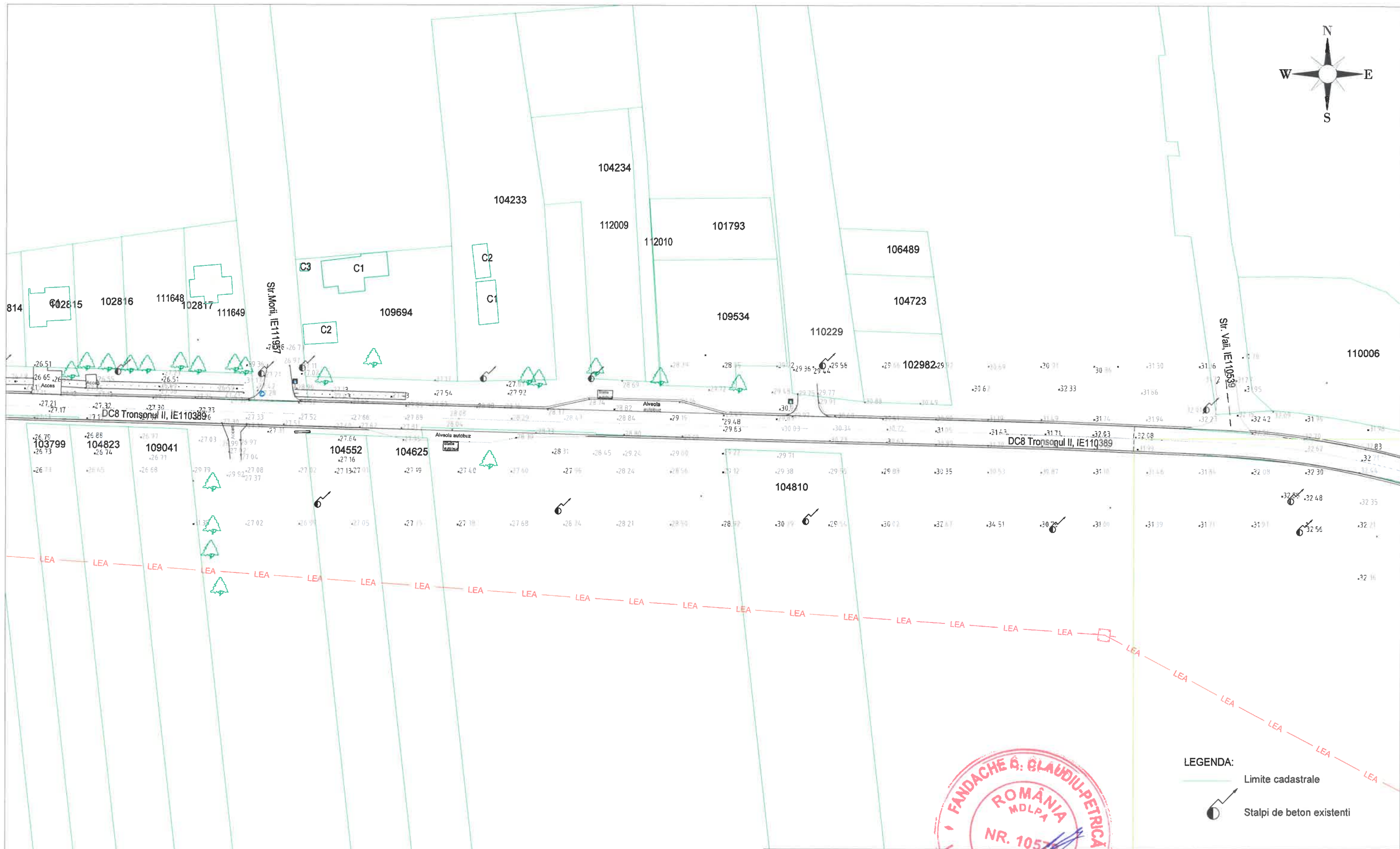
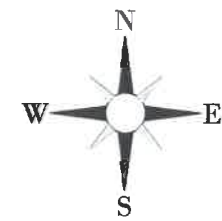

LEGENDA:
 — Limite cadastrale
 ● Stalpi de beton existenti



HARTA PLANURILOR

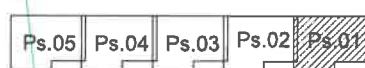

Verificator	Nume	Semnatura	Cerinta	Referat nr./data	
Proiectant:	1 ENGINEERING		Beneficiar:		Proiect nr.
1ENGINEERING SRL • RO28725629 • J13/1567/2011 • CONSTANTA, B-DUL TOMIS, NR.143A			COMUNA LIMANU, JUDEȚUL CONSTANȚA		241/2024
Sef proiect	ing.Sorin PANA	<i>[Signature]</i>	Scara	Faza:	
Proiectat	ing.Andreea ANTOHI	<i>[Signature]</i>	1:1000	P.T.+D.E.	
Verificat	ing.Sorin PANA	<i>[Signature]</i>	Data	PLAN DE SITUATIE EXISTENTA	
			APRILIE 2024	TRASEE PISTE BICICLETE	
				Plansa nr. Pe.01	

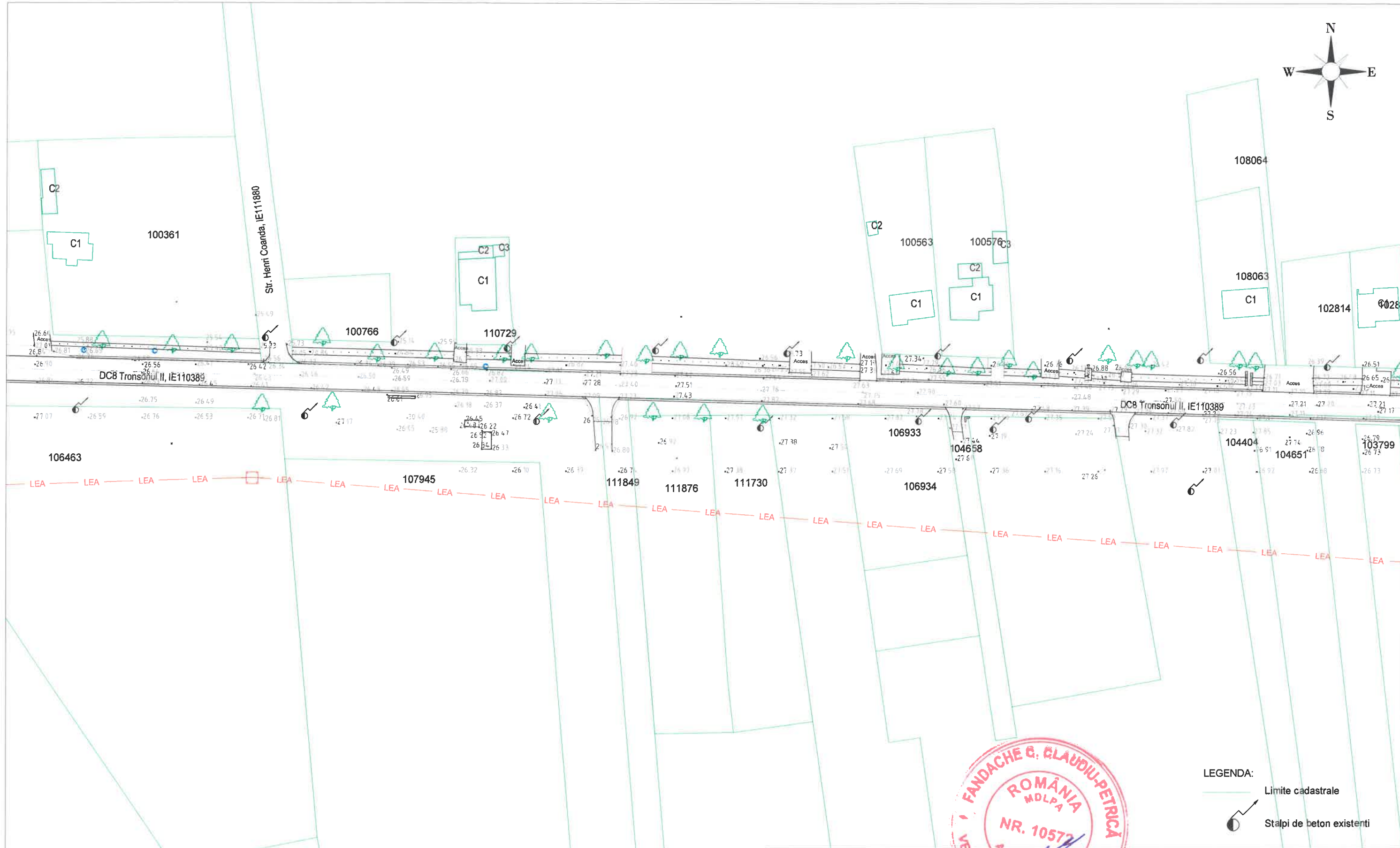
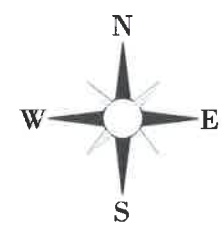



LEGENDA:
 Limite cadastrale
 Stalpi de beton existenti

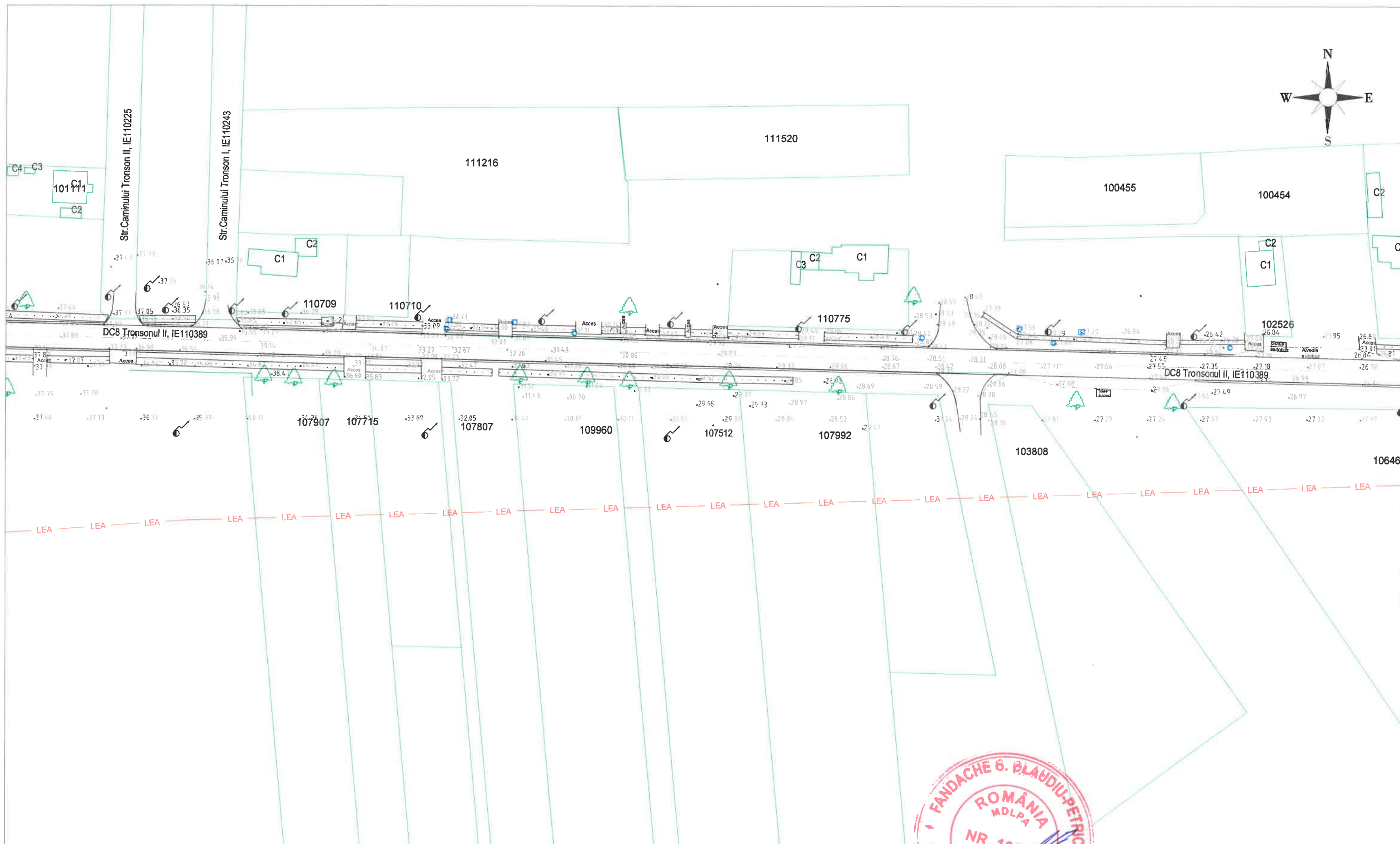
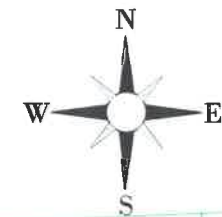

Verificator	Nume	Semnatura	Referat nr./data
Proiectant:	1 ENGINEERING		Beneficiar: COMUNA LIMANU, JUDEȚUL CONSTANȚA
1ENGINEERING SRL • RO28725629 • J13/1567/2011 • CONSTANȚA, B-DUL TOMIS, NR.143A			Proiect nr. 241/2024
Sef proiect	ing.Sorin PANA		Faza: P.T.+D.E.
Proiectat	ing.Andreea ANTOHI		PLAN DE SITUATIE EXISTENTA TRASEE PISTE BICICLETE
Verificat	ing.Sorin PANA		
		Scara 1:1000	ASIGURAREA INFRASTRUCTURII PENTRU TRANSPORT VERDE - PISTA DE BICICLETE IN COMUNA LIMANU, JUDEȚUL CONSTANTA
		Data APRILIE 2024	



LEGENDA:

-  Limite cadastrale
-  Stalpi de beton existenti

HARTA PLANURILOR

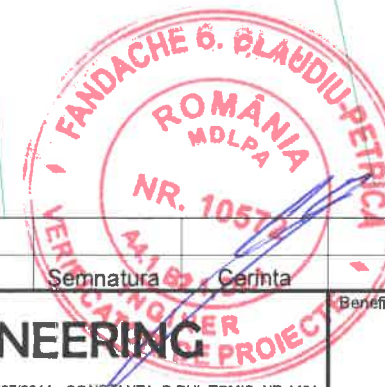
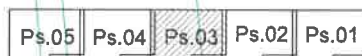

Verificator	Nume	Semnatura	Carinta	Referat nr./data
Proiectant:	1 ENGINEERING		Beneficiar:	COMUNA LIMANU, JUDEȚUL CONSTANȚA
1ENGINEERING SRL • RO28725829 • J13/1567/2011 • CONSTANTA, B-DUL TOMIS, NR.143A				Proiect nr. 241/2024
Sef proiect	ing.Sorin PANA		Scara 1:1000	Faza: P.T.+D.E.
Proiectat	ing.Andreea ANTOHI		Data APRILIE 2024	Planșa nr. Pe.03
Verificat	ing.Sorin PANA			ASIGURAREA INFRASTRUCTURII PENTRU TRANSPORT VERDE - PISTA DE BICICLETE IN COMUNA LIMANU, JUDEȚUL CONSTANTA
				PLAN DE SITUATIE EXISTENTA TRASEE PISTE BICICLETE

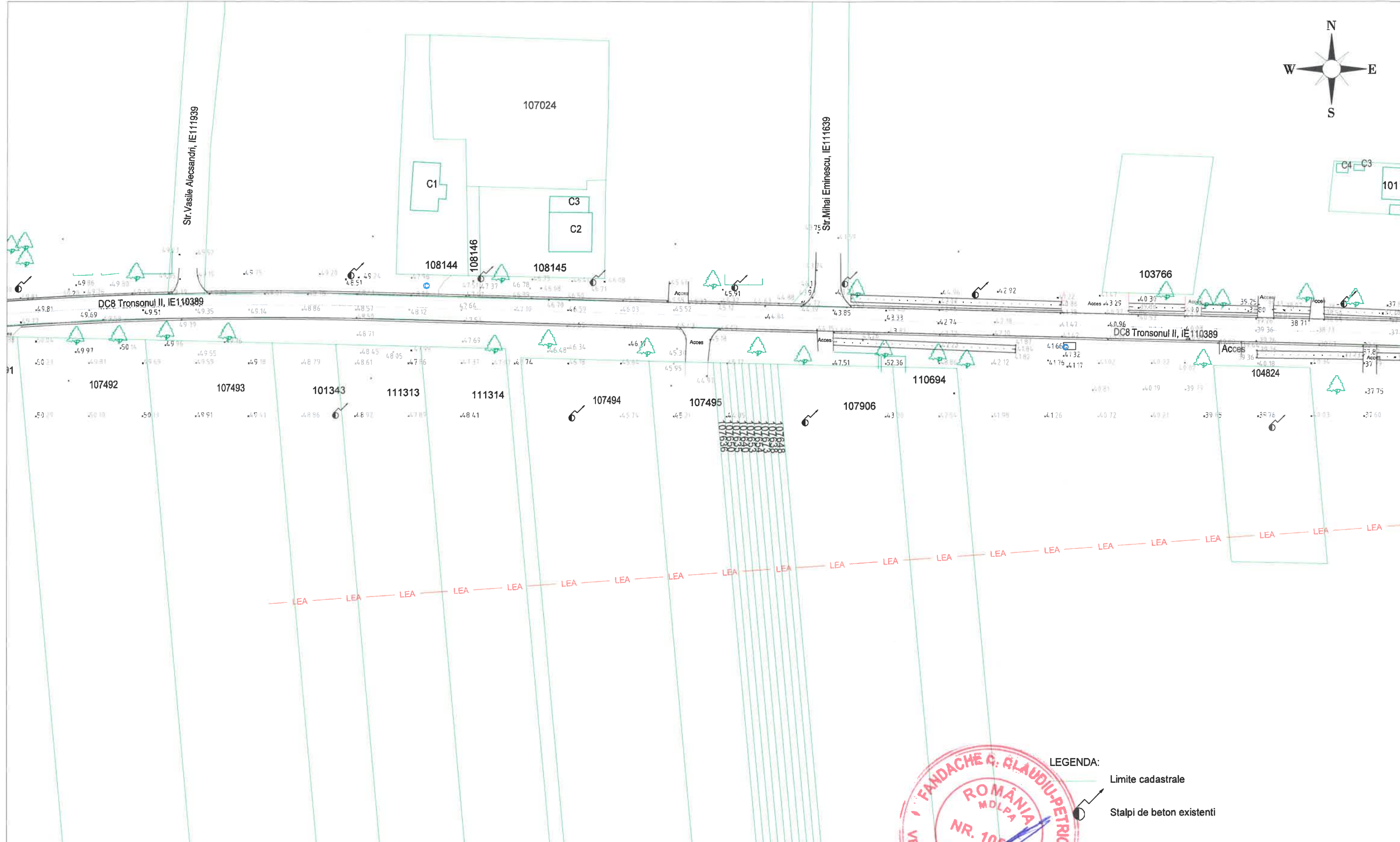
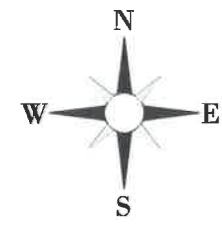

LEGENDA:
 Limite cadastrale
 Stalpi de beton existenti

Verificator	Nume	Semnatura	Cerinta	Referat nr./data	
Proiectant:	1ENGINEERING			Beneficiar:	Proiect nr.
1ENGINEERING SRL • RO28725829 • J13/1567/2011 • CONSTANTA, B-DUL TOMIS, NR.143A				COMUNA LIMANU, JUDEȚUL CONSTANȚA	241/2024
Sef proiect	ing.Sorin PANA		Scara	ASIGURAREA INFRASTRUCTURII PENTRU TRANSPORT VERDE - PISTA DE BICICLETE IN COMUNA LIMANU, JUDEȚUL CONSTANTA	Faza:
Proiectat	ing.Andreea ANTOHI		1:1000		P.T.+D.E.
Verificat	ing.Sorin PANA		Data	PLAN DE SITUATIE EXISTENTA TRASEE PISTE BICICLETE	Plansa nr.
			APRILIE 2024		Pe.04

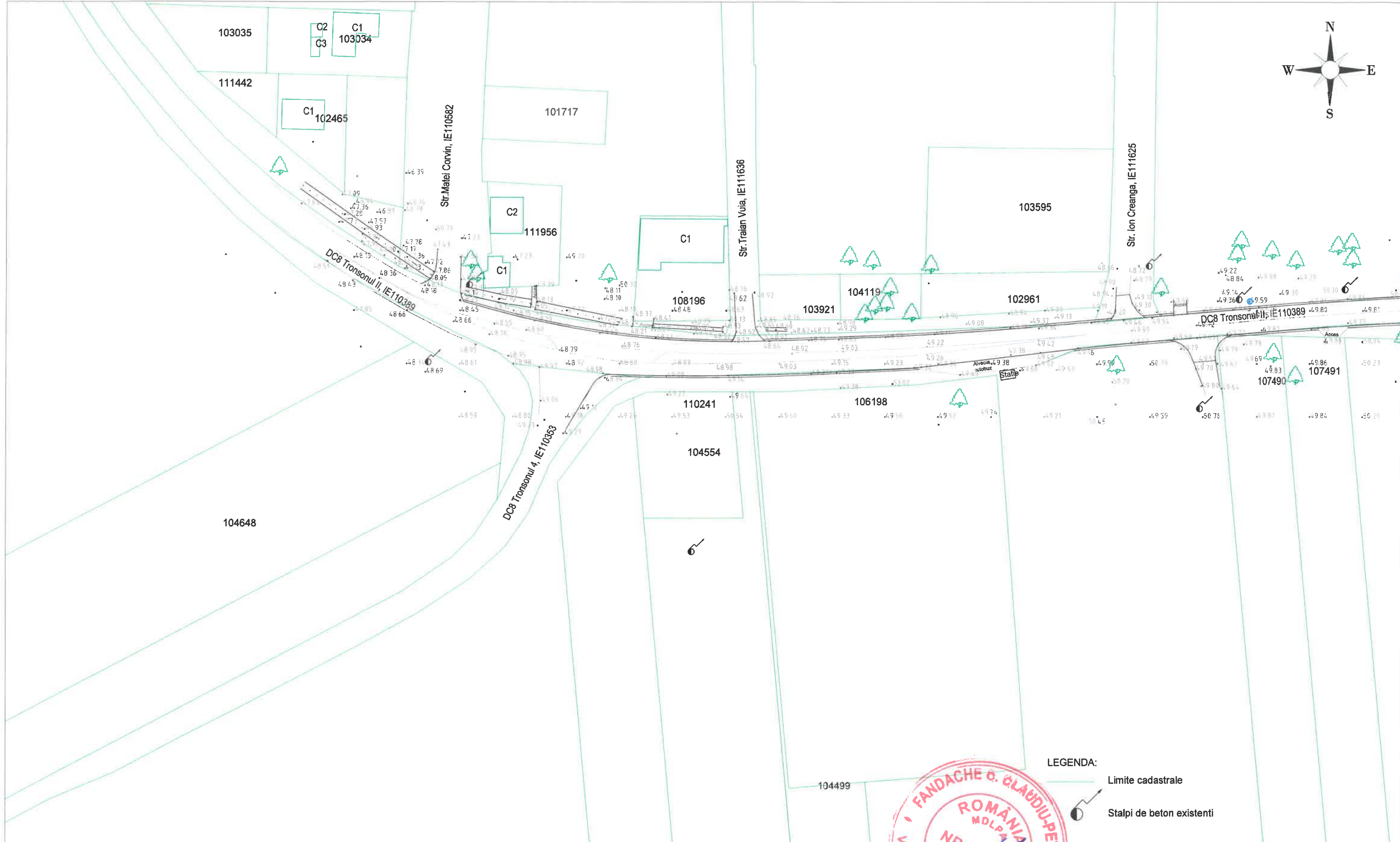
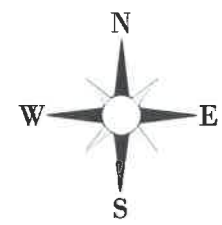









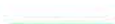

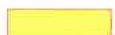

LEGENDA:
 Limite cadastrale
 Stalpi de beton existenti

HARTA PLANURILOR
 Ps.05 Ps.04 Ps.03 Ps.02 Ps.01



Verificator	Nume	Semnatura	Cerinta	Referat nr./data	
Proiectant:	1ENGINEERING			Beneficiar:	Proiect nr.
1ENGINEERING SRL • RO28725629 • J13/1567/2011 • CONSTANȚA, B-DUL TOMIS, NR.143A				COMUNA LIMANU, JUDEȚUL CONSTANȚA	241/2024
Sef proiect	ing.Sorin PANA		Scara	Faza:	
Proiectat	ing.Andreea ANTOHI		1:1000	P.T.+D.E.	
Verificat	ing.Sorin PANA		Data	PLAN DE SITUATIE EXISTENTA	
			APRILIE 2024	TRASEE PISTE BICICLETE	
				Pe.05	

- LEGENDA:**
-  Limite cadastrale
 -  Parapet mana curenta
 -  Suprafata carosabila pista biciclete
 -  Zid de sprijin tip L
 -  Stalpi de beton existenti
 -  Stalpi de iluminat propusi
 -  Rigola carosabila
 -  Camera de cadere 90x100 cm
 -  Teava PVC 315x7.7 mm, SN4
 -  Borduri monolite
 -  2 x Teava PVC 110x3.2 mm, SN4
 -  Rigola pereata
 -  Sant pereat

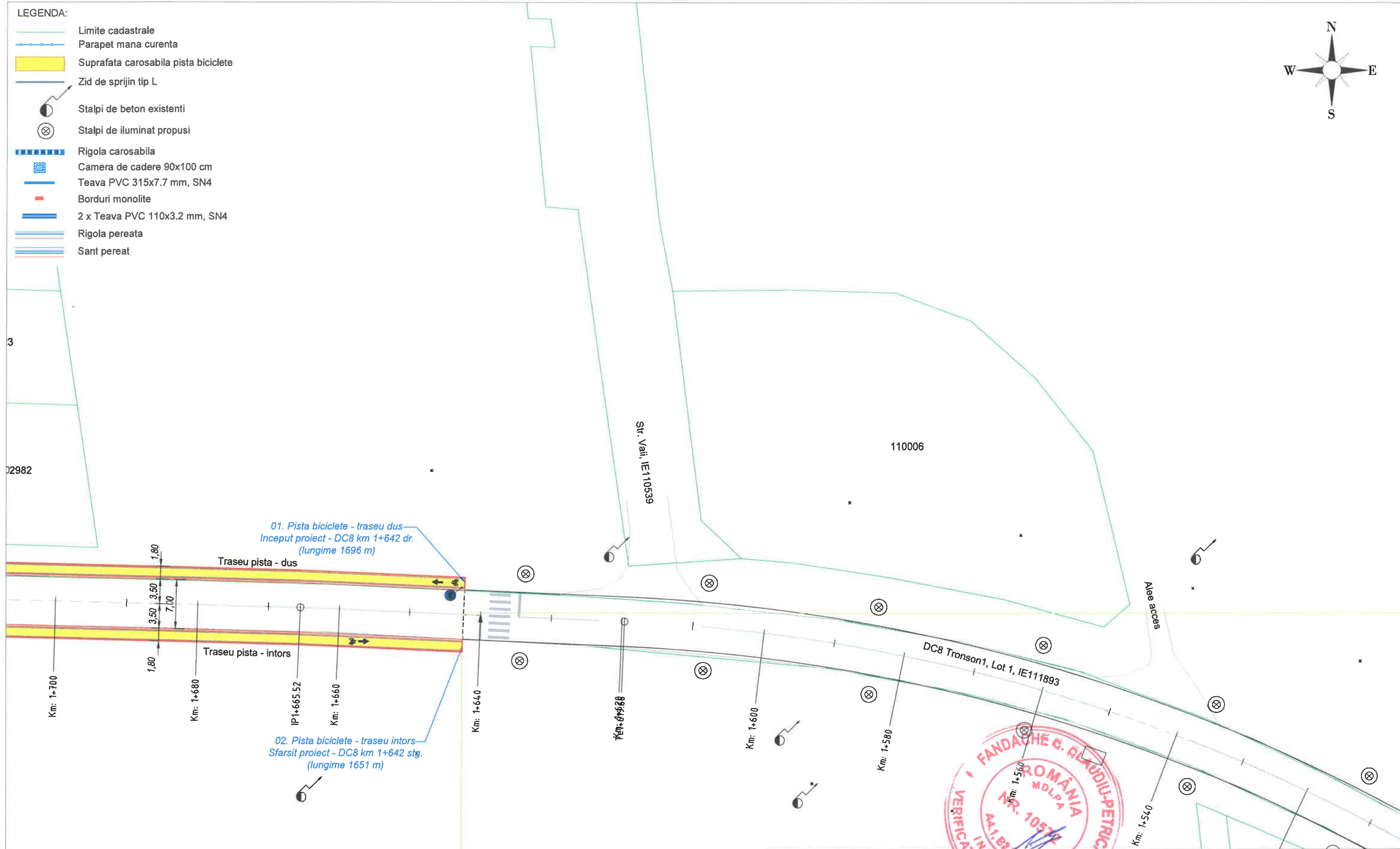
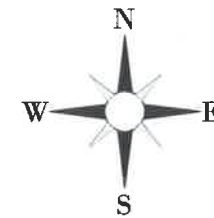



01. Pista biciclete - traseu dus
Inceput proiect - DC8 km 1+642 dr.
(lungime 1696 m)

02. Pista biciclete - traseu intors
Sfarsit proiect - DC8 km 1+642 stg.
(lungime 1651 m)

HARTA PLANURILOR



Verificator	Nume	Semnatura	Cerinta	Referat nr./data
Proiectant:	ENGINEERING		Beneficiar:	COMUNA LIMANU, JUDEȚUL CONSTANȚA
INGINEERING SRL • RO28725629 • J13/1567/2011 • CONSTANTA, B-DUL TOMIS, NR.143A				Proiect nr. 241/2024
Sef proiect	ing.Sorin PANA		Scara 1:500	Faza: P.T.+D.E.
Proiectat	ing.Andreea ANTOHI		Data APRILIE 2024	Planșa nr. Ps.01
Verificat	ing.Sorin PANA			PLAN DE SITUATIE PROPUȘA TRASEE PISTE BICICLETE



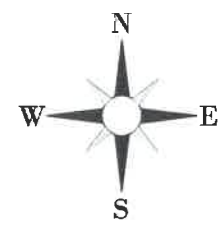

- LEGENDA:**
- Limite cadastrale
 - Parapet mana curenta
 - Suprafata carosabila pista biciclete
 - Zid de sprijin tip L
 - Stalpi de beton existenti
 - Stalpi de iluminat propusi
 - Rigola carosabila
 - Camera de cadere 90x100 cm
 - Teava PVC 315x7.7 mm, SN4
 - Borduri monolite
 - 2 x Teava PVC 110x3.2 mm, SN4
 - Rigola pereata
 - Sant pereat

HARTA PLANURILOR

Ps.10	Ps.09	Ps.08	Ps.07	Ps.06	Ps.05	Ps.04	Ps.03	Ps.02	Ps.01
-------	-------	-------	-------	-------	-------	-------	-------	-------	-------



Verificator	Nume	Semnatura	Cerinta	Referat nr./data	
Proiectant:	1 ENGINEERING			Beneficiar:	
1ENGINEERING SRL • RO28725629 • J1315872011 • CONSTANTA, B-DUL TOMIS, NR.143A				COMUNA LIMANU, JUDEȚUL CONSTANȚA	
Sef proiect	ing.Sorin PANA		Scara 1:500	ASIGURAREA INFRASTRUCTURII PENTRU TRANSPORT VERDE - PISTA DE BICICLETE IN COMUNA LIMANU, JUDEȚUL CONSTANTA	
Proiectat	ing.Andreea ANTOHI		Data APRILIE 2024	Faza: P.T.+D.E.	
Verificat	ing.Sorin PANA			PLAN DE SITUATIE PROPUSA TRASEE PISTE BICICLETE	
				Planșa nr. Ps.02	

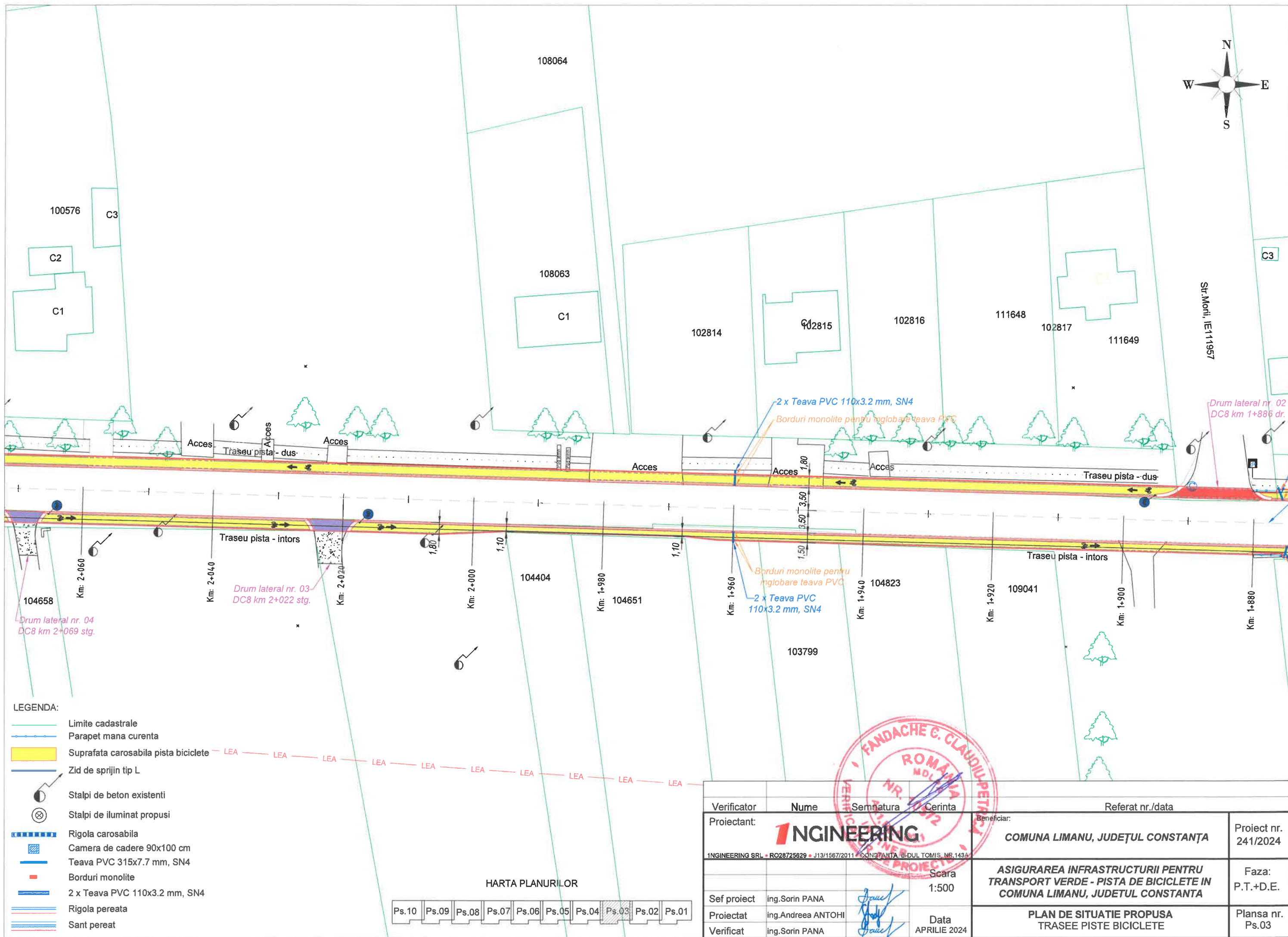
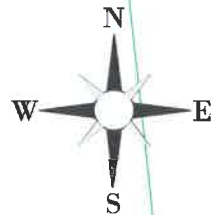

LEGENDA:

- Limite cadastrale
- Parapet mana curenta
- Suprafata carosabila pista biciclete
- Zid de sprijin tip L
-
 Stalpi de beton existenti
-
 Stalpi de iluminat propusi
- Rigola carosabila
- Camera de cadere 90x100 cm
- Teava PVC 315x7.7 mm, SN4
- Borduri monolite
- 2 x Teava PVC 110x3.2 mm, SN4
- Rigola pereata
- Sant pereat

HARTA PLANURILOR

- Ps.10
- Ps.09
- Ps.08
- Ps.07
- Ps.06
- Ps.05
- Ps.04
- Ps.03
- Ps.02
- Ps.01



Verificator	Nume	Semnatura	Cerinta	Referat nr./data
Proiectant:	1 ENGINEERING		Beneficiar: COMUNA LIMANU, JUDEȚUL CONSTANȚA	
Sef proiect			ing.Sorin PANA	Proiect nr. 241/2024
Proiectat			ing.Andreea ANTOHI	Faza: P.T.+D.E.
Verificat			ing.Sorin PANA	Planșa nr. Ps.03
			Scara: 1:500	ASIGURAREA INFRASTRUCTURII PENTRU TRANSPORT VERDE - PISTA DE BICICLETE IN COMUNA LIMANU, JUDEȚUL CONSTANTA
			Data: APRILIE 2024	PLAN DE SITUATIE PROPUSA TRASEE PISTE BICICLETE

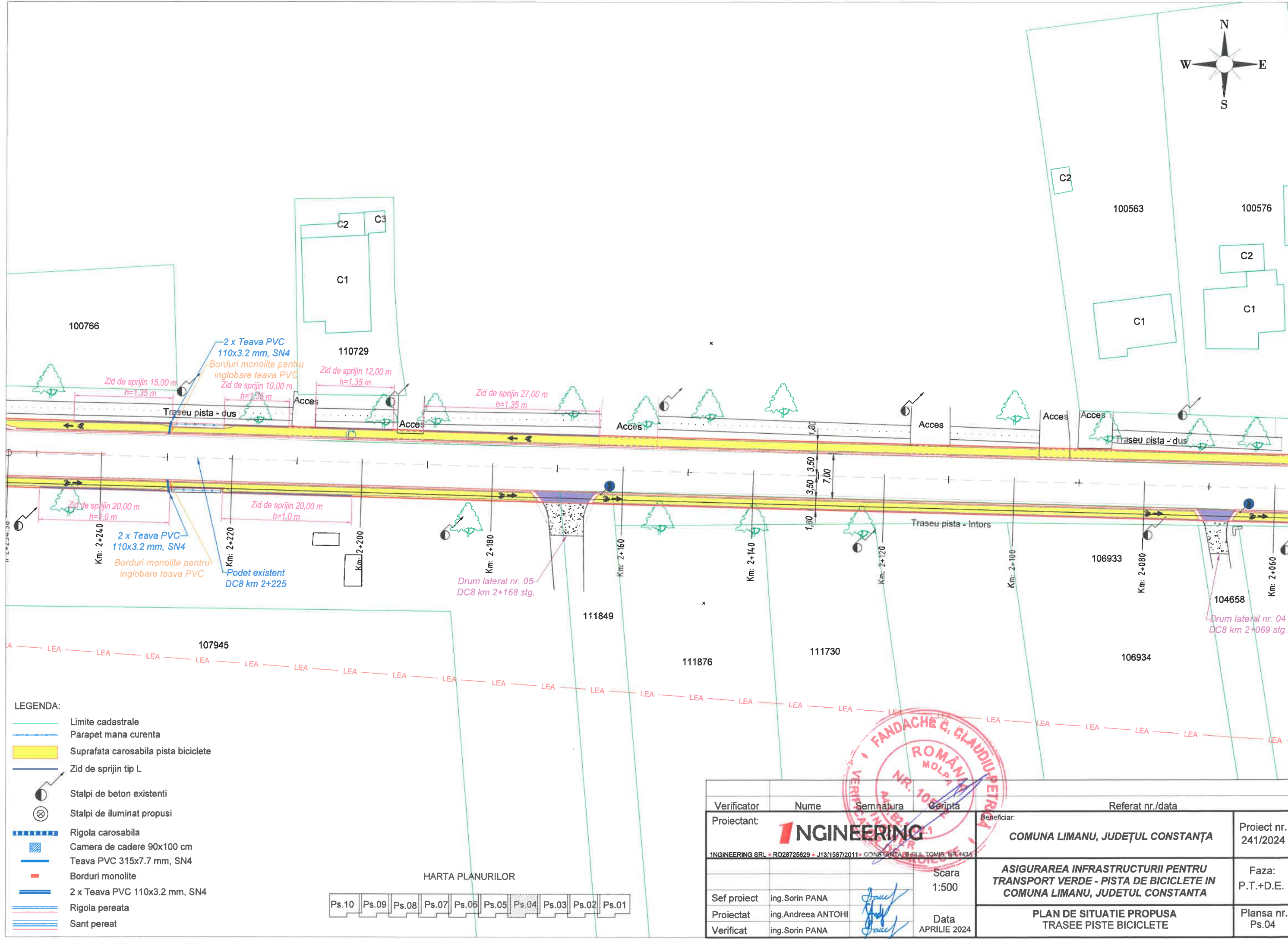
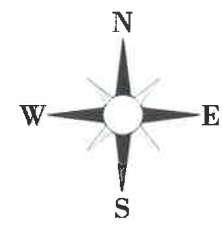

- LEGENDA:**
- Limite cadastrale
 - Parapet mana curenta
 - Suprafata carosabila pista biciclete
 - Zid de sprijin tip L
 - Stalpi de beton existenti
 - Stalpi de iluminat propusi
 - Rigola carosabila
 - Camera de cadere 90x100 cm
 - Teava PVC 315x7.7 mm, SN4
 - Borduri monolite
 - 2 x Teava PVC 110x3.2 mm, SN4
 - Rigola pereata
 - Sant pereat

HARTA PLANURILOR

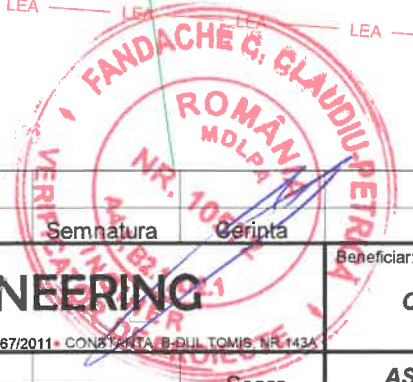
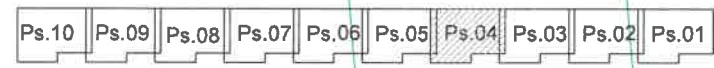

Verificator	Nume	Semnatura	Seripta	Referat nr./data
Proiectant:	1 ENGINEERING			Beneficiar:
1ENGINEERING SRL • RO28725629 • J13/1567/2011 • CONSTANTA, B-DUL TOMIS, NR.143A				COMUNA LIMANU, JUDEȚUL CONSTANȚA
Sef proiect	ing.Sorin PANA		Scara 1:500	Proiect nr. 241/2024
Proiectat	ing.Andreea ANTOHI		Data APRILIE 2024	Faza: P.T.+D.E.
Verificat	ing.Sorin PANA			PLAN DE SITUATIE PROPU SA TRASEE PISTE BICICLETE

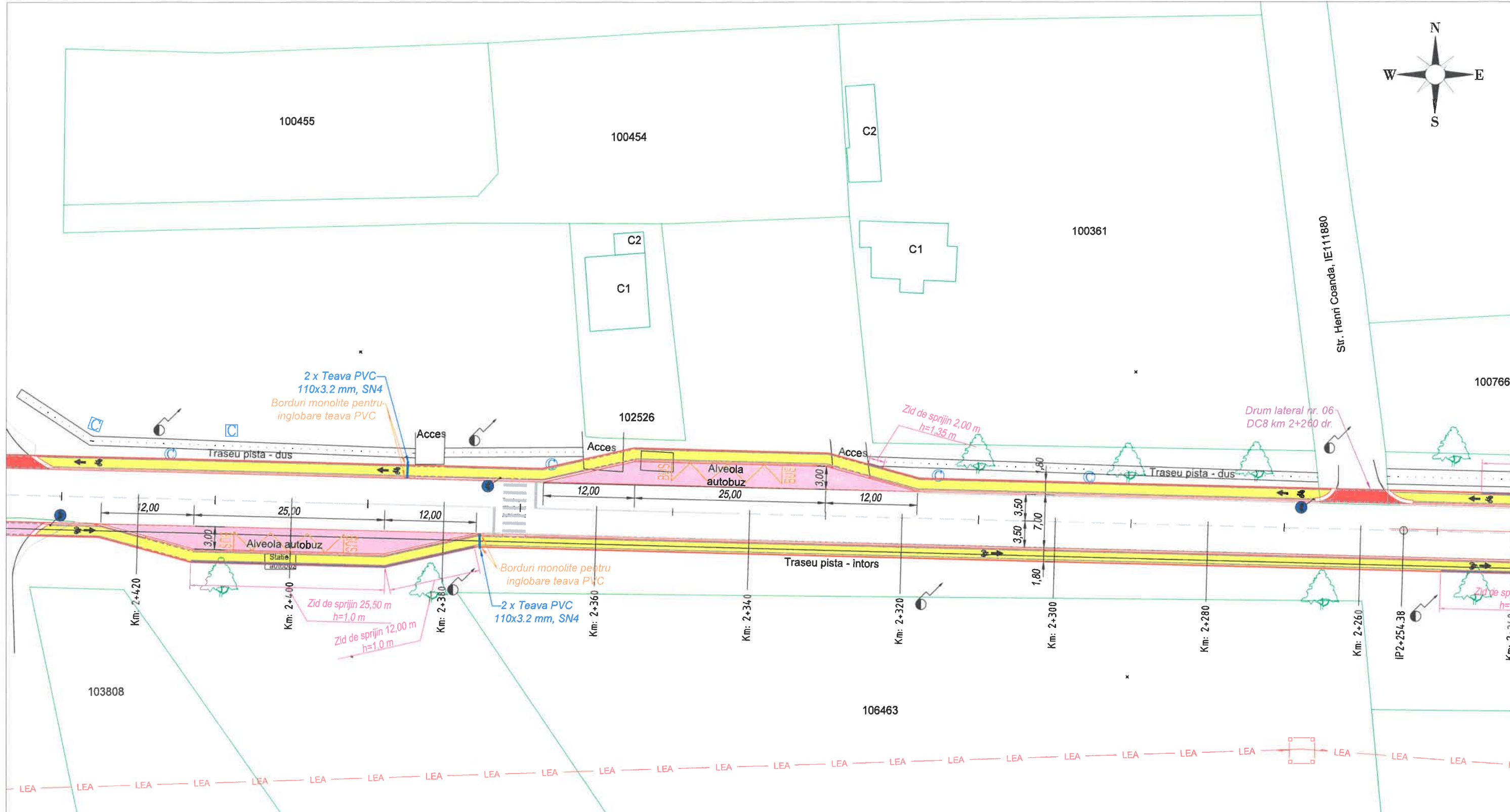
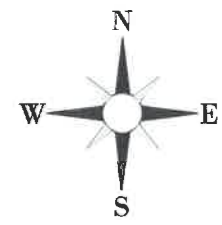

- LEGENDA:**
- Limite cadastrale
 - Parapet mana curenta
 - Suprafata carosabila pista biciclete
 - Zid de sprijin tip L
 - Stalpi de beton existenti
 - ⊗ Stalpi de iluminat propusi
 - Rigola carosabila
 - Camera de cadere 90x100 cm
 - Teava PVC 315x7.7 mm, SN4
 - Borduri monolite
 - 2 x Teava PVC 110x3.2 mm, SN4
 - Rigola pereata
 - Sant pereat

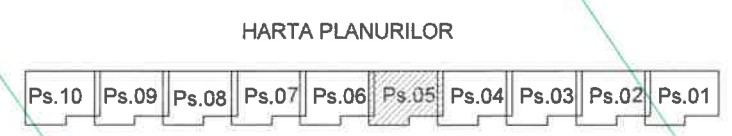

Verificator	Nume	Semnatura	Cerinta	Referat nr./data
Proiectant:	1ENGINEERING		Beneficiar:	COMUNA LIMANU, JUDEȚUL CONSTANȚA
1ENGINEERING SRL • RO28725629 • J13/1567/2011 • CONSTANȚA, B-DUL TOMIS, NR.143A				Proiect nr. 241/2024
Sef proiect	ing.Sorin PANA		Scara 1:500	Faza: P.T.+D.E.
Proiectat	ing.Andreea ANTOHI		Data APRILIE 2024	Planșa nr. Ps.05
Verificat	ing.Sorin PANA			PLAN DE SITUATIE PROPUSA TRASEE PISTE BICICLETE

111520

111216

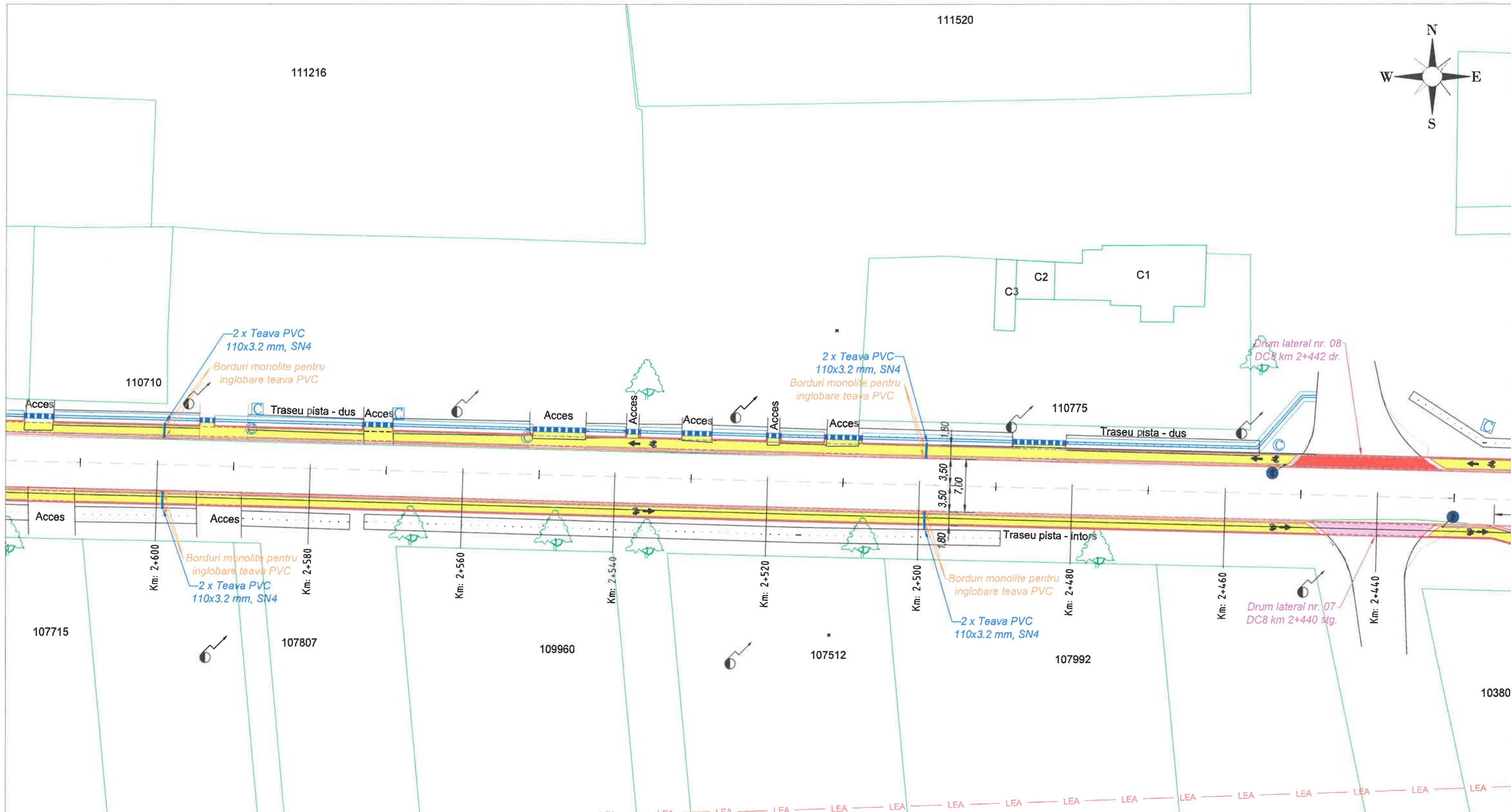
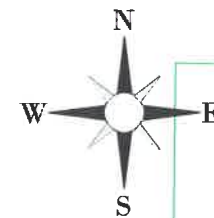

LEGENDA:

- Limite cadastrale
- Parapet mana curenta
- Suprafata carosabila pista biciclete
- Zid de sprijin tip L
- Stalpi de beton existenti
- Stalpi de iluminat propusi
- Rigola carosabila
- Camera de cadere 90x100 cm
- Teava PVC 315x7.7 mm, SN4
- Borduri monolite
- 2 x Teava PVC 110x3.2 mm, SN4
- Rigola pereata
- Sant pereat

HARTA PLANURILOR

Ps.10 Ps.09 Ps.08 Ps.07 Ps.06 Ps.05 Ps.04 Ps.03 Ps.02 Ps.01

Verificator	Nume	Semnatura	Scara	Referat nr./data	
Proiectant:	1 ENGINEERING		1:500	Beneficiar:	Proiect nr. 241/2024
1ENGINEERING SRL • RO28725629 • J13/1567/2011 • CONSTANTA, B-DUL TOMIS, NR.143A				COMUNA LIMANU, JUDEȚUL CONSTANȚA	
Sef proiect	ing.Sorin PANA			ASIGURAREA INFRASTRUCTURII PENTRU TRANSPORT VERDE - PISTA DE BICICLETE IN COMUNA LIMANU, JUDEȚUL CONSTANTA	Faza: P.T.+D.E.
Proiectat	ing.Andreea ANTOHI		Data	PLAN DE SITUATIE PROPU SA TRASEE PISTE BICICLETE	Plansa nr. Ps.06
Verificat	ing.Sorin PANA		APRILIE 2024		

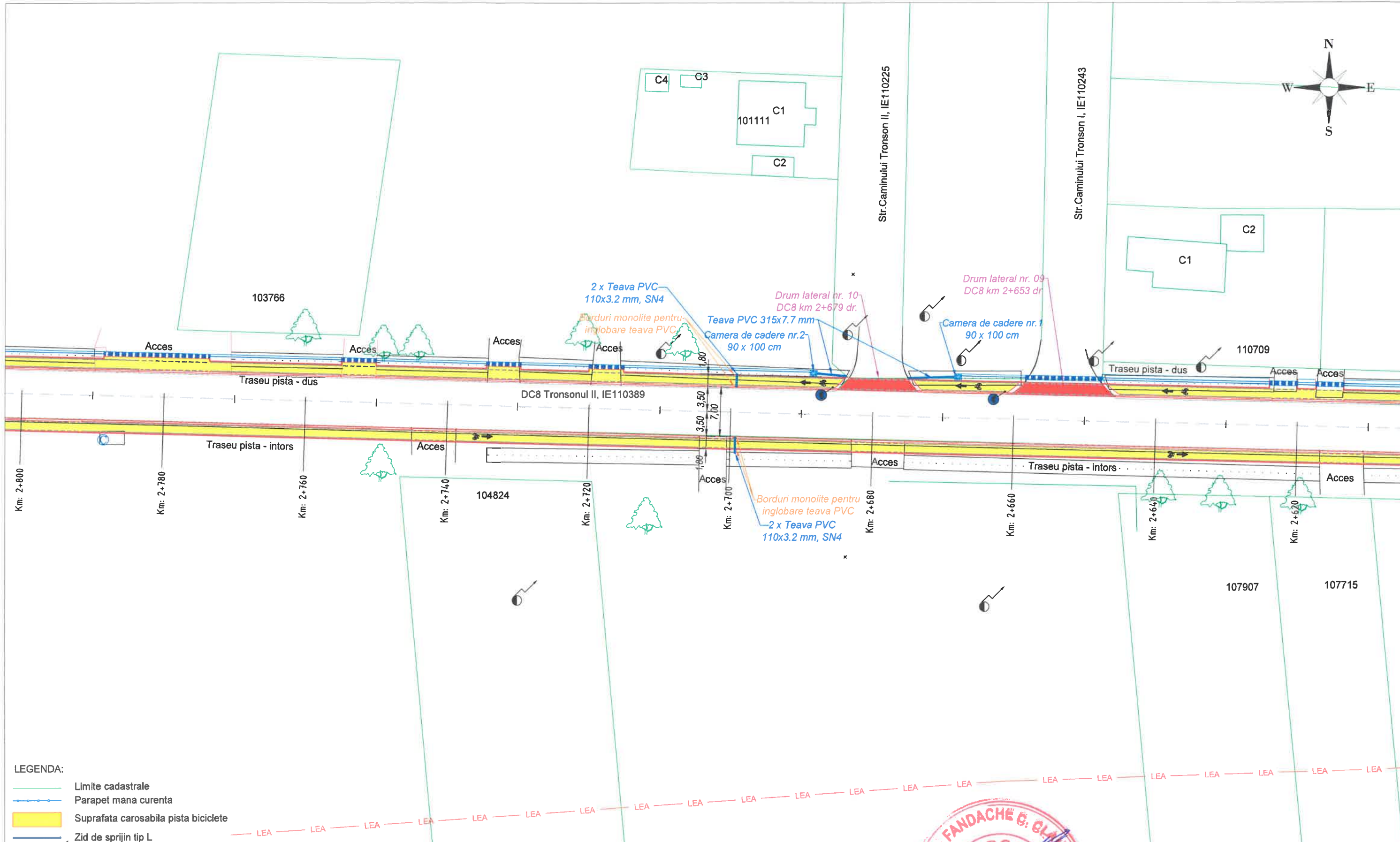
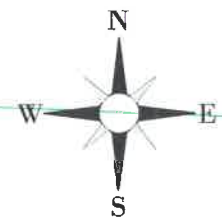

- LEGENDA:**
- Limite cadastrale
 - Parapet mana curenta
 - Suprafata carosabila pista biciclete
 - Zid de sprijin tip L
 - Stalpi de beton existenti
 - Stalpi de iluminat propusi
 - Rigola carosabila
 - Camera de cadere 90x100 cm
 - Teava PVC 315x7.7 mm, SN4
 - Borduri monolite
 - 2 x Teava PVC 110x3.2 mm, SN4
 - Rigola pereata
 - Sant pereat

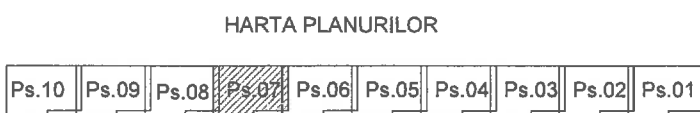

Verificator	Nume	Semnatura	Cerinta	Referat nr./data
Proiectant:	1 ENGINEERING		ROMANIA 19572	Beneficiar:
			Scara 1:500	COMUNA LIMANU, JUDEȚUL CONSTANȚA
			Data APRILIE 2024	ASIGURAREA INFRASTRUCTURII PENTRU TRANSPORT VERDE - PISTA DE BICICLETE IN COMUNA LIMANU, JUDEȚUL CONSTANTA
Sef proiect	ing.Sorin PANA			Proiect nr. 241/2024
Proiectat	ing.Andreea ANTOHI			Faza: P.T.+D.E.
Verificat	ing.Sorin PANA			Plansa nr. Ps.07

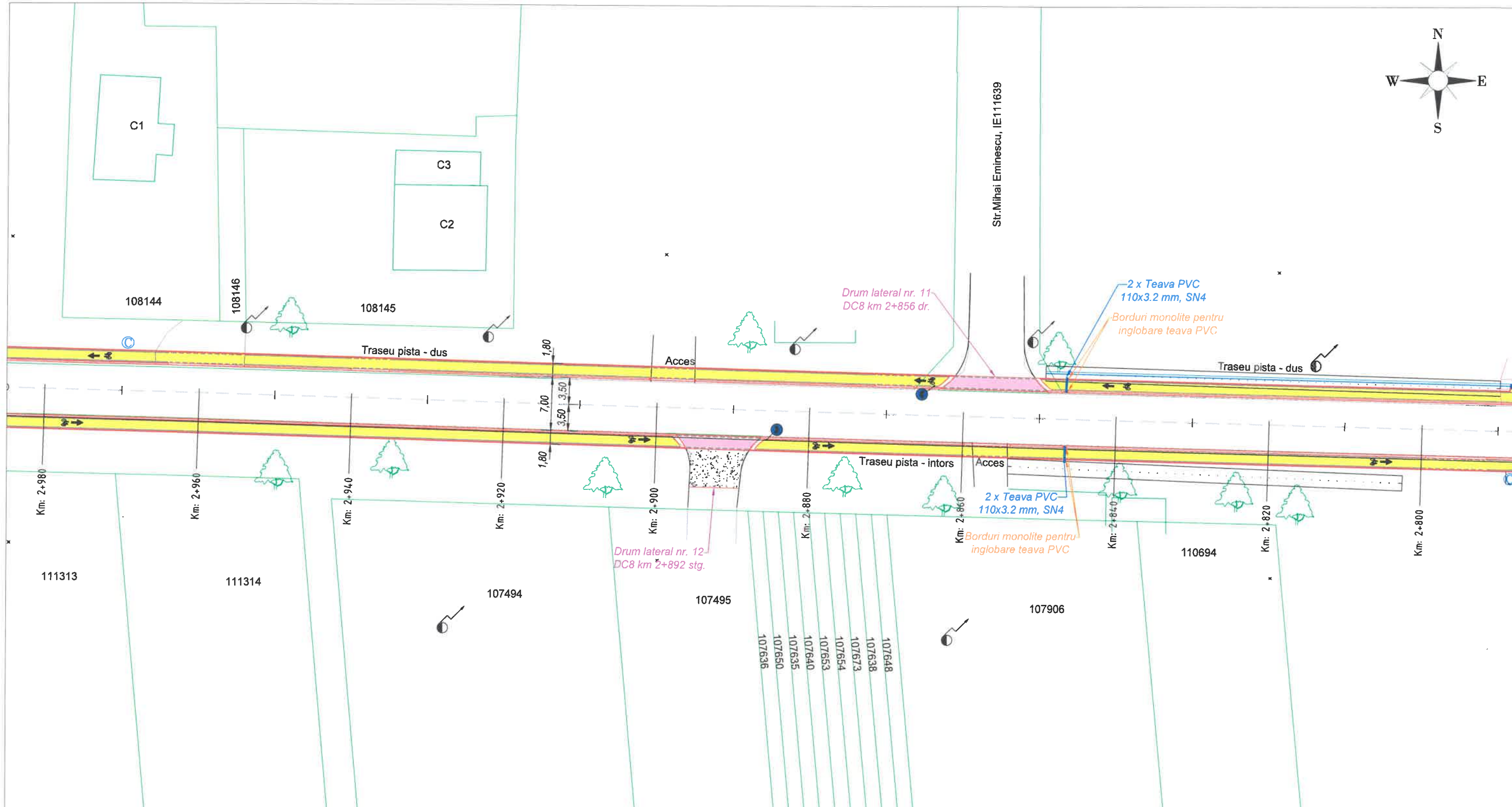
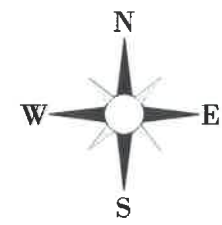

- LEGENDA:**
- Limite cadastrale
 - Parapet mana curenta
 - Suprafata carosabila pista biciclete
 - Zid de sprijin tip L
 - Stalpi de beton existenti
 - Stalpi de iluminat propusi
 - Rigola carosabila
 - Camera de cadere 90x100 cm
 - Teava PVC 315x7.7 mm, SN4
 - Borduri monolite
 - 2 x Teava PVC 110x3.2 mm, SN4
 - Rigola pereata
 - Sant pereat

LEA — LEA — LEA — LEA — LEA — LEA — L

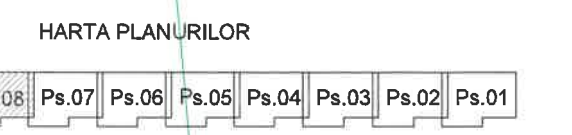
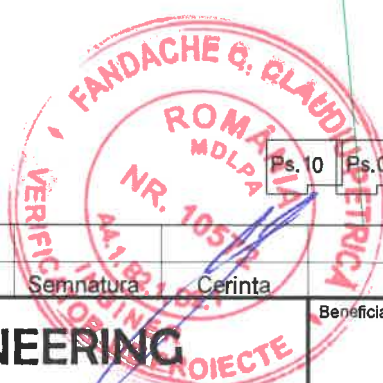

Verificator	Nume	Semnatura	Cerinta	Referat nr./data	
Proiectant:	1ENGINEERING			Beneficiar: COMUNA LIMANU, JUDEȚUL CONSTANȚA	
1ENGINEERING SRL • RO28725629 • J13/1567/2011 • CONSTANȚA, B-DUL TOMIS, NR.143A				Scara 1:500	Proiect nr. 241/2024
Sef proiect	ing.Sorin PANA			ASIGURAREA INFRASTRUCTURII PENTRU TRANSPORT VERDE - PISTA DE BICICLETE IN COMUNA LIMANU, JUDEȚUL CONSTANTA	
Proiectat	ing.Andreea ANTOHI		Data APRILIE 2024	Faza: P.T.+D.E.	
Verificat	ing.Sorin PANA			Planșa nr. Ps.08	

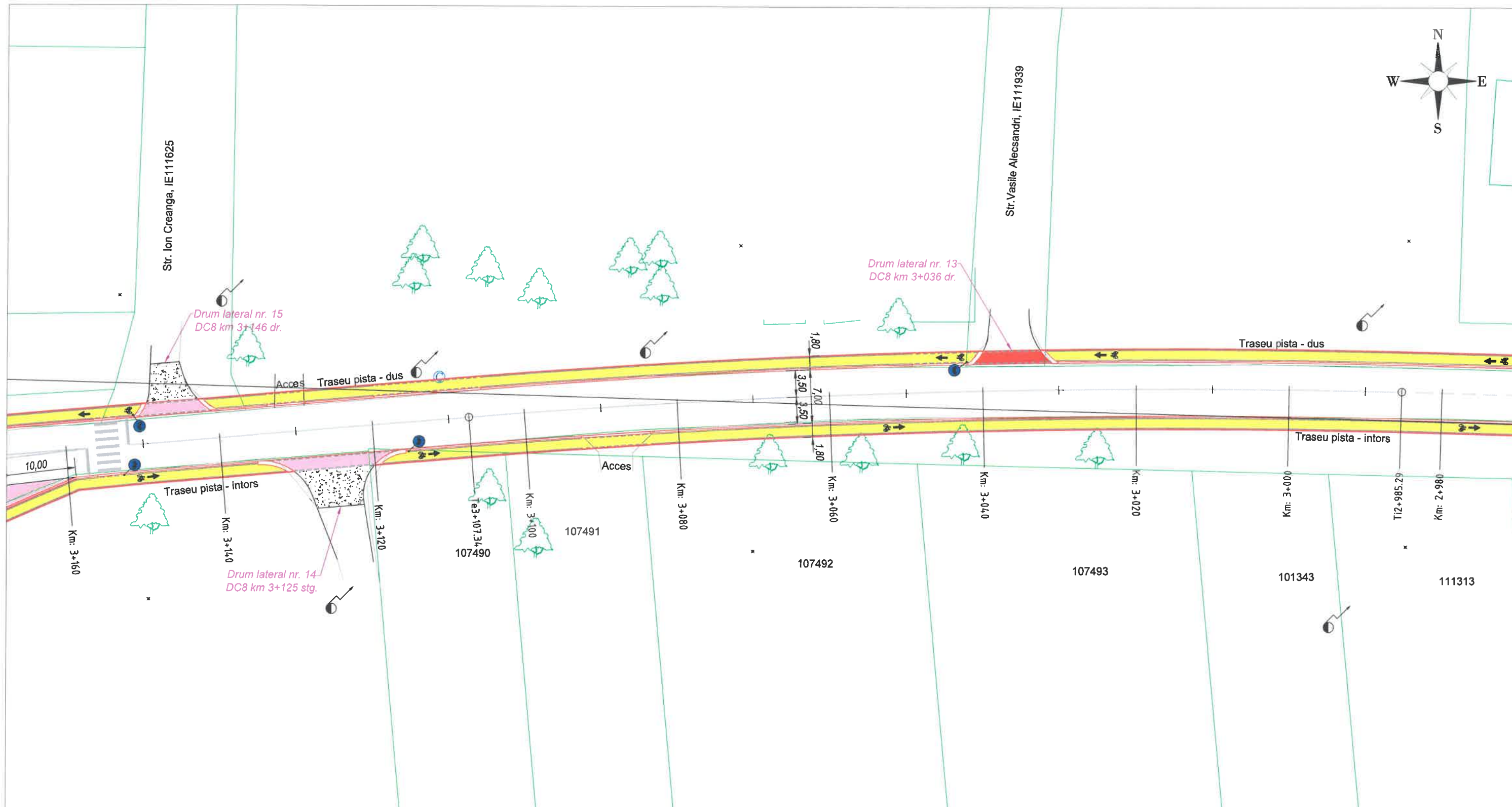
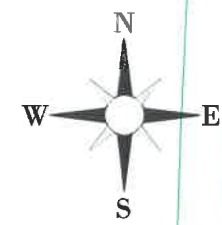

- LEGENDA:**
- Limite cadastrale
 - Parapet mana curenta
 - Suprafata carosabila pista biciclete
 - Zid de sprijin tip L
 - Stalpi de beton existenti
 - Stalpi de iluminat propusi
 - Rigola carosabila
 - Camera de cadere 90x100 cm
 - Teava PVC 315x7.7 mm, SN4
 - Borduri monolite
 - 2 x Teava PVC 110x3.2 mm, SN4
 - Rigola pereata
 - Sant pereat

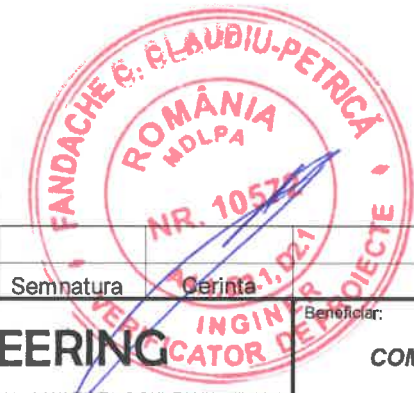
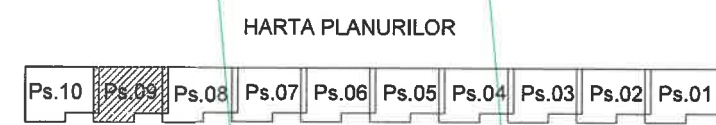

Verificator	Nume	Semnatura	Carinta	Referat nr./data
Proiectant:	1 ENGINEERING		Beneficiar:	COMUNA LIMANU, JUDEȚUL CONSTANȚA
INGINEERING SRL • RO28725629 • J13/1567/2011 • CONSTANTA, B-DUL TOMIS, NR.143A			Scara	ASIGURAREA INFRASTRUCTURII PENTRU TRANSPORT VERDE - PISTA DE BICICLETE IN COMUNA LIMANU, JUDEȚUL CONSTANTA
Sef proiect	ing.Sorin PANA		1:500	Faza: P.T.+D.E.
Proiectat	ing.Andreea ANTOHI		Data	PLAN DE SITUATIE PROPU SA TRASEE PISTE BICICLETE
Verificat	ing.Sorin PANA		APRILIE 2024	Planșa nr. Ps.09

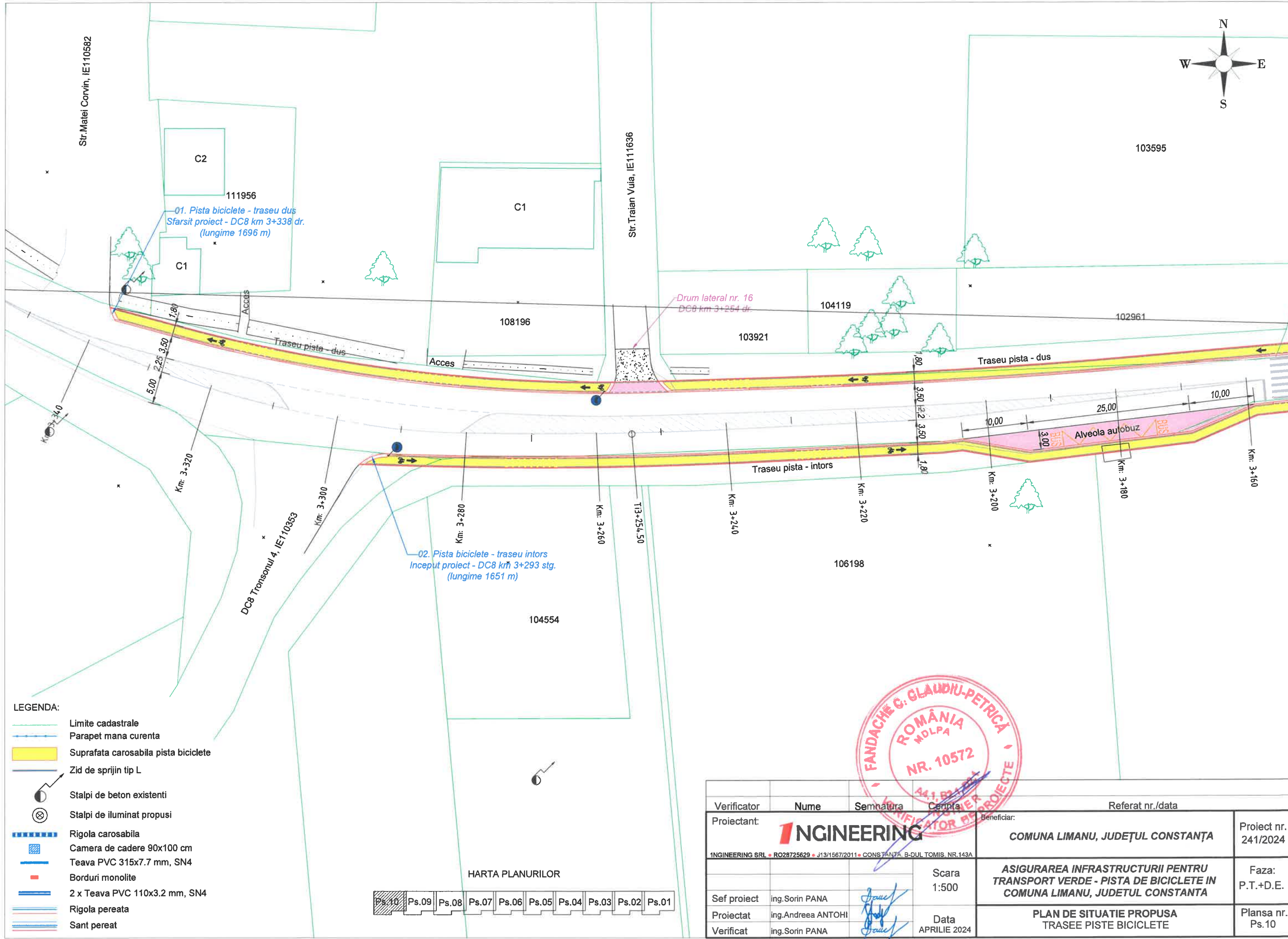
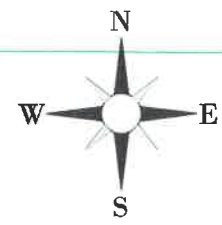

- LEGENDA:**
- Limite cadastrale
 - Parapet mana curenta
 - Suprafata carosabila pista biciclete
 - Zid de sprijin tip L
 - Stalpi de beton existenti
 - Stalpi de iluminat propusi
 - Rigola carosabila
 - Camera de cadere 90x100 cm
 - Teava PVC 315x7.7 mm, SN4
 - Borduri monolite
 - 2 x Teava PVC 110x3.2 mm, SN4
 - Rigola pereata
 - Sant pereat



Verificator	Nume	Semnatura	Scara	Referat nr./data
Proiectant:	1 ENGINEERING		Beneficiar:	COMUNA LIMANU, JUDEȚUL CONSTANȚA
1ENGINEERING SRL • RO28725629 • J13/1567/2011 • CONSTANȚA, B-DUL TOMIS, NR.143A			Scara	Faza:
Sef proiect	ing.Sorin PANA		1:500	P.T.+D.E.
Proiectat	ing.Andreea ANTOHI		Data	PLAN DE SITUATIE PROPUSA
Verificat	ing.Sorin PANA		APRILIE 2024	TRASEE PISTE BICICLETE
				Planșa nr. Ps.10

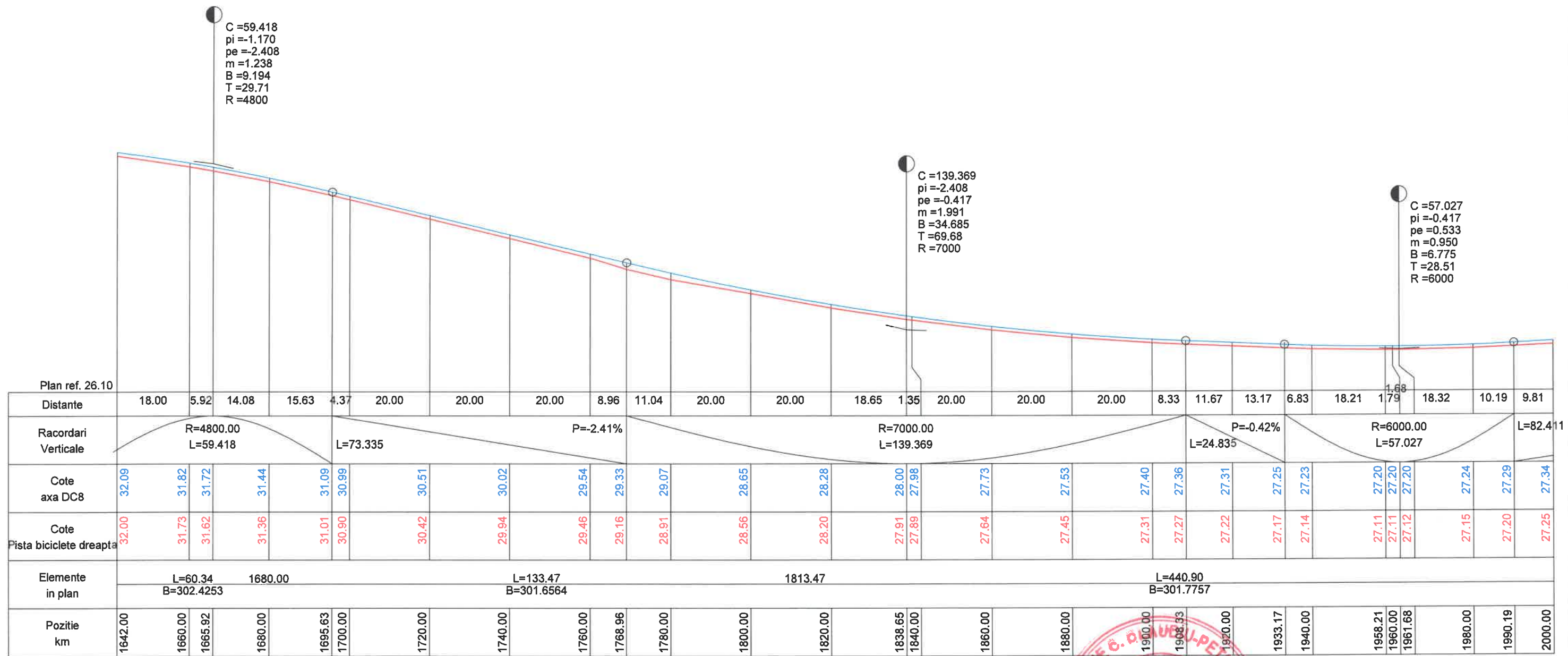

C = 59.418
pi = -1.170
pe = -2.408
m = 1.238
B = 9.194
T = 29.71
R = 4800

C = 139.369
pi = -2.408
pe = -0.417
m = 1.991
B = 34.685
T = 69.68
R = 7000

C = 57.027
pi = -0.417
pe = 0.533
m = 0.950
B = 6.775
T = 28.51
R = 6000



Verificator	Nume	Semnatura	Caranta	Referat nr./data
Proiectant:	INGINEERING			Beneficiar: COMUNA LIMANU, JUDEȚUL CONSTANȚA
INGINEERING SRL • RO28725629 • J13/1567/2011 • CONSTANȚA, B-DUL TOMIS, NR. 143A				Proiect nr. 241/2024
Sef proiect	ing. Sorin PANA	<i>[Signature]</i>	Scara 1:1000 / 1:100	Faza: P.T.+D.E.
Proiectat	ing. Andreea ANTOHI	<i>[Signature]</i>	Data APRILIE 2024	Plansa nr. L1.01
Verificat	ing. Sorin PANA	<i>[Signature]</i>		
				ASIGURAREA INFRASTRUCTURII PENTRU TRANSPORT VERDE - PISTA DE BICICLETE IN COMUNA LIMANU, JUDEȚUL CONSTANȚA
				PROFIL LONGITUDINAL PISTA BICICLETE DREAPTA - TRASEU DUS

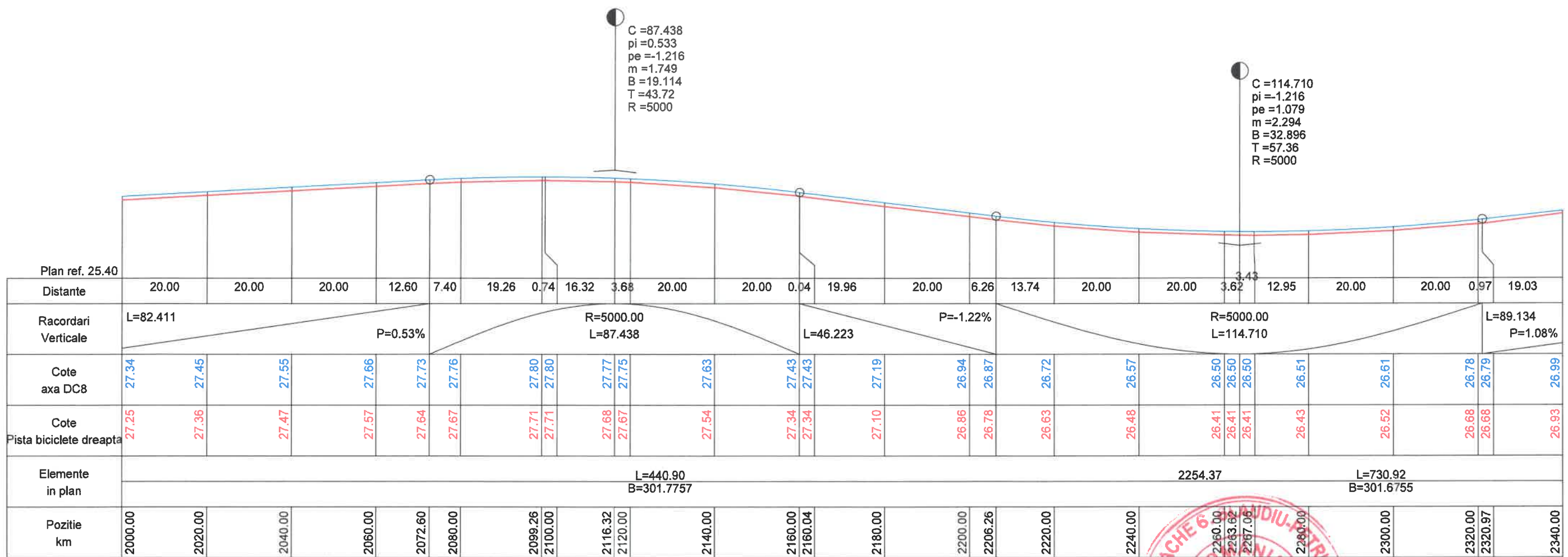

C = 87.438
pi = 0.533
pe = -1.216
m = 1.749
B = 19.114
T = 43.72
R = 5000

C = 114.710
pi = -1.216
pe = 1.079
m = 2.294
B = 32.896
T = 57.36
R = 5000



Verificator	Nume	Semnatura	Scara	Referat nr./data
Proiectant:	1 ENGINEERING		Beneficiar:	COMUNA LIMANU, JUDEȚUL CONSTANȚA
1ENGINEERING SRL • RO28725629 • J13/1567/2011 • CONSTANȚA • B-DUL TOMIS, NR.143A			Scara	1:1000 / 1:100
Sef proiect	ing.Sorin PANA	<i>[Signature]</i>	Date	APRILIE 2024
Proiectat	ing.Andreea ANTOHI	<i>[Signature]</i>	ASIGURAREA INFRASTRUCTURII PENTRU TRANSPORT VERDE - PISTA DE BICICLETE IN COMUNA LIMANU, JUDEȚUL CONSTANTA	
Verificat	ing.Sorin PANA	<i>[Signature]</i>	PROFIL LONGITUDINAL PISTA BICICLETE DREAPTA - TRASEU DUS	
				Proiect nr. 241/2024
				Faza: P.T.+D.E.
				Plansa nr. L1.02

C = 156.736
 pi = 3.285
 pe = -0.633
 m = 3.918
 B = 76.769
 T = 78.37
 R = 4000

C = 50.369
 pi = 3.915
 pe = 3.285
 m = 0.630
 B = 3.964
 T = 25.18
 R = 8000

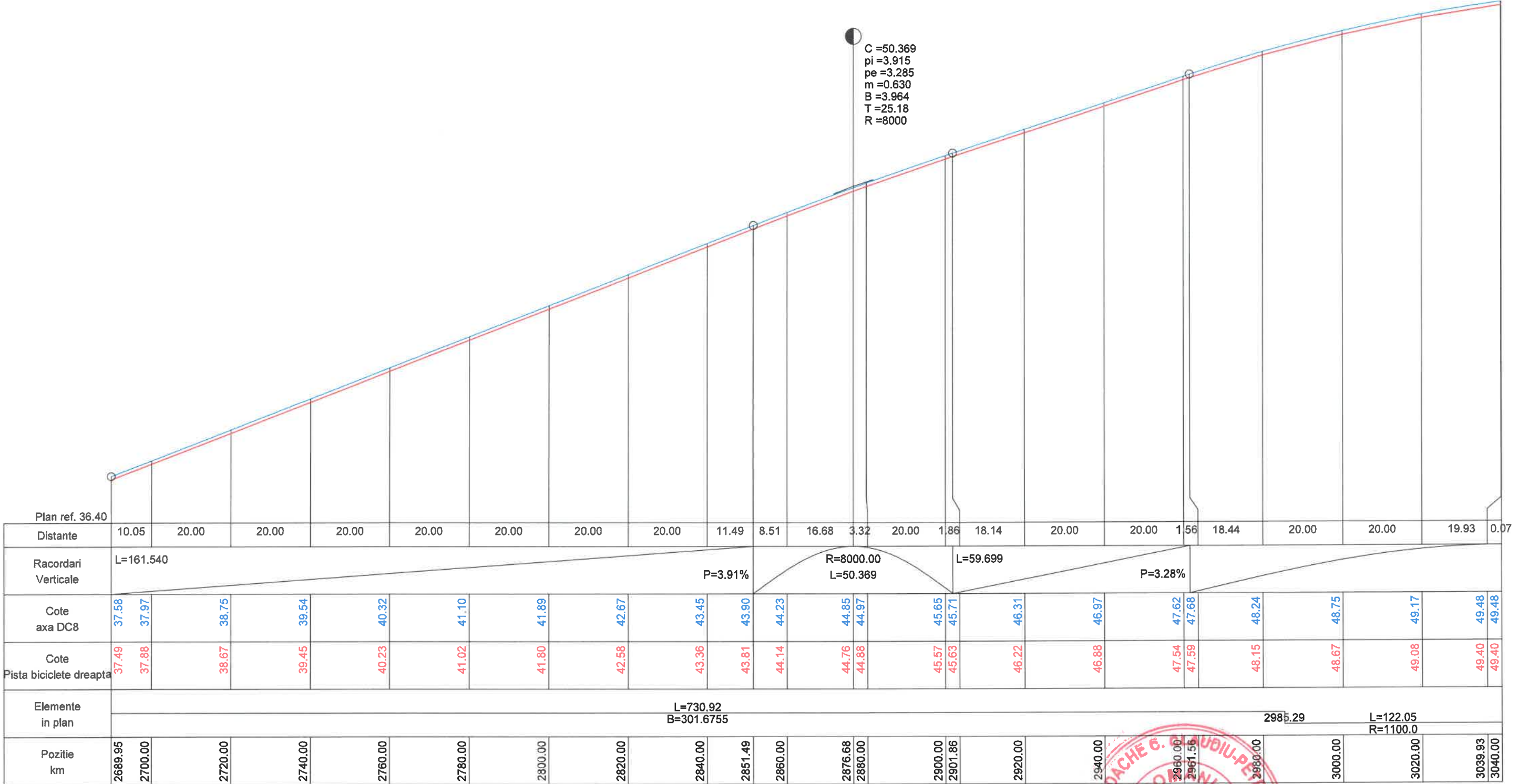

Plan ref. 36.40	10.05	20.00	20.00	20.00	20.00	20.00	20.00	20.00	11.49	8.51	16.68	3.32	20.00	1.86	18.14	20.00	20.00	1.56	18.44	20.00	20.00	19.93	0.07				
Racordari Verticale	L=161.540										P=3.91%					R=8000.00 L=50.369		L=59.699					P=3.28%				
Cote axa DC8	37.58	37.97	38.75	39.54	40.32	41.10	41.89	42.67	43.45	43.90	44.23	44.85	44.97	45.65	45.71	46.31	46.97	47.62	47.68	48.24	48.75	49.17	49.48	49.48			
Cote Pista biciclete dreapta	37.49	37.88	38.67	39.45	40.23	41.02	41.80	42.58	43.36	43.81	44.14	44.76	44.88	45.57	45.63	46.22	46.88	47.54	47.59	48.15	48.67	49.08	49.40	49.40			
Elemente in plan	L=730.92 B=301.6755										2985.29										L=122.05 R=1100.0						
Pozitie km	2689.95	2700.00	2720.00	2740.00	2760.00	2780.00	2800.00	2820.00	2840.00	2851.49	2860.00	2876.68	2880.00	2900.00	2901.86	2920.00	2940.00	2960.00	2961.56	2980.00	3000.00	3020.00	3039.93	3040.00			

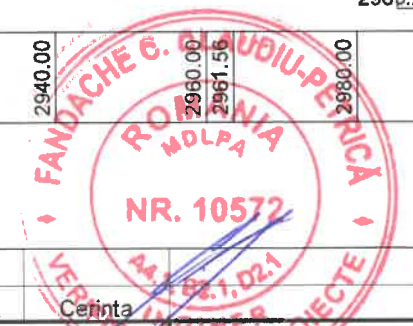

Verificator	Nume	Semnatura	Cerinta	Referat nr./data
Proiectant:	ENGINEERING		Beneficiar	COMUNA LIMANU, JUDEȚUL CONSTANȚA
INGINEERING SRL • RO28725629 • J13/1567/2011 • CONSTANTA B-DUL TOMIS NR.143A			Scara	1:1000 /1:100
Sef proiect	ing.Sorin PANA	<i>[Signature]</i>	Date	APRILIE 2024
Proiectat	ing.Andreea ANTOHI	<i>[Signature]</i>	ASIGURAREA INFRASTRUCTURII PENTRU TRANSPORT VERDE - PISTA DE BICICLETE IN COMUNA LIMANU, JUDEȚUL CONSTANTA	
Verificat	ing.Sorin PANA	<i>[Signature]</i>	PROFIL LONGITUDINAL PISTA BICICLETE DREAPTA - TRASEU DUS	
				Proiect nr. 241/2024
				Faza: P.T.+D.E.
				Plansa nr. L1.04

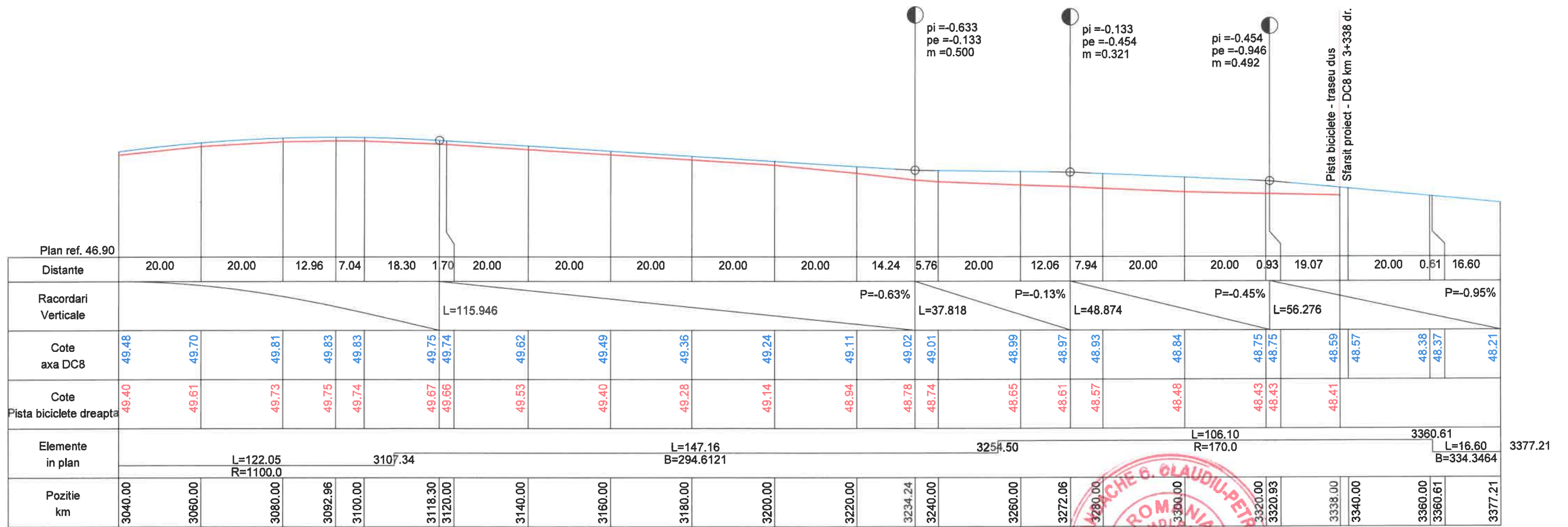

Verificator	Nume	Semnatura	Cerinta	Referat nr./data
Proiectant:	1 INGEENING		Beneficiar:	COMUNA LIMANU, JUDEȚUL CONSTANȚA
1 INGEENING SRL • RO28725629 • J13/1567/2011 • CONSTANȚA, B-DUL TOMIS, NR.143A				Proiect nr. 241/2024
Sef proiect	ing.Sorin PANA	<i>[Signature]</i>	Scara 1:1000 / 1:100	Faza: P.T.+D.E.
Proiectat	ing.Andreea ANTOHI	<i>[Signature]</i>	Data APRILIE 2024	Plansa nr. L1.05
Verificat	ing.Sorin PANA	<i>[Signature]</i>		
				ASIGURAREA INFRASTRUCTURII PENTRU TRANSPORT VERDE - PISTA DE BICICLETE IN COMUNA LIMANU, JUDEȚUL CONSTANȚA
				PROFIL LONGITUDINAL PISTA BICICLETE DREAPTA - TRASEU DUS

C = 59.418
 pi = -1.170
 pe = -2.408
 m = 1.238
 B = 9.194
 T = 29.71
 R = 4800

C = 139.369
 pi = -2.408
 pe = -0.417
 m = 1.991
 B = 34.685
 T = 69.68
 R = 7000

C = 57.027
 pi = -0.417
 pe = -0.533
 m = 0.950
 B = 6.775
 T = 28.51
 R = 6000

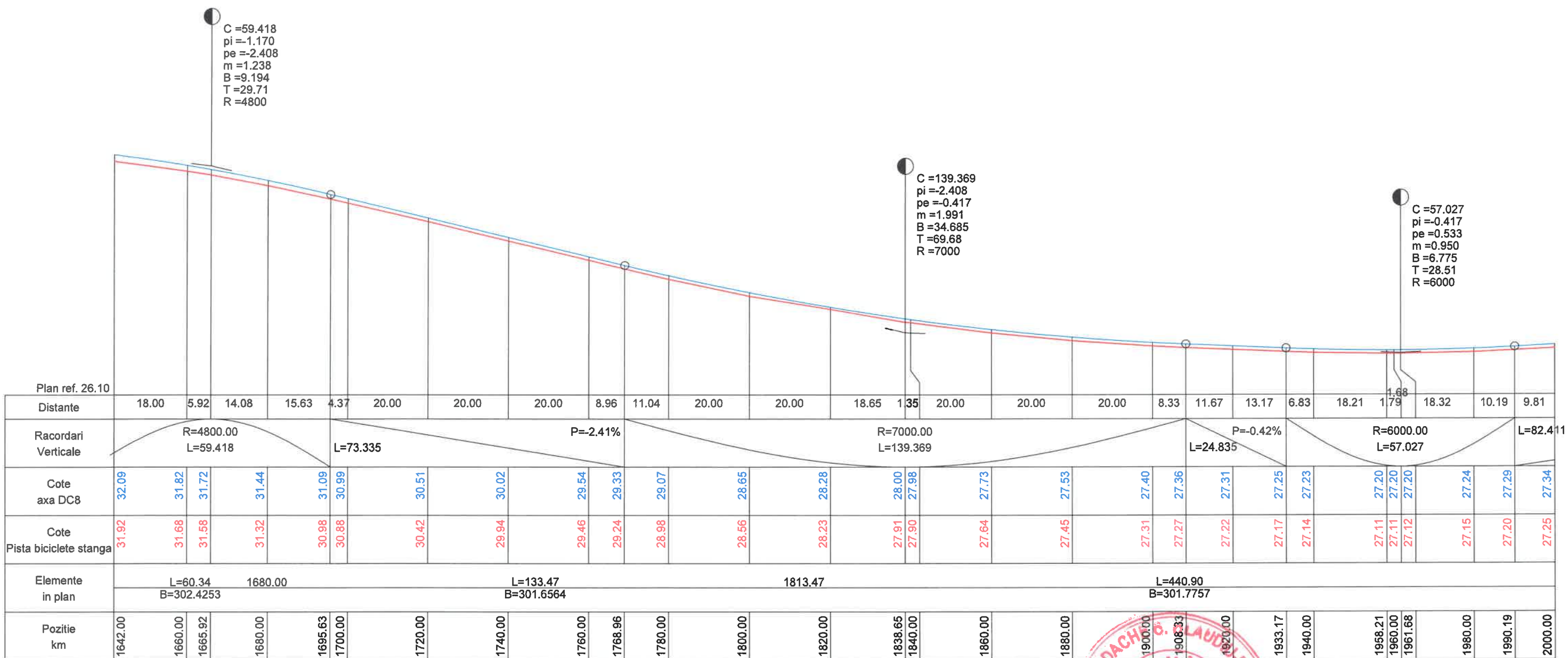

Verificator	Nume	Semnatura	Cerinta	Referat nr./data
Proiectant:	1ENGINEERING			Beneficiar: COMUNA LIMANU, JUDEȚUL CONSTANȚA
1ENGINEERING SRL • RO28725629 • J13/1567/2011 • CONSTANȚA, B-DUL TOMIS, NR.143A				Proiect nr. 241/2024
Sef proiect	ing.Sorin PANA	<i>[Signature]</i>	Scara 1:1000 /1:100	Faza: P.T.+D.E.
Proiectat	ing.Andreea ANTOHI	<i>[Signature]</i>	Data APRILIE 2024	Plansa nr. L2.01
Verificat	ing.Sorin PANA	<i>[Signature]</i>		
				ASIGURAREA INFRASTRUCTURII PENTRU TRANSPORT VERDE - PISTA DE BICICLETE IN COMUNA LIMANU, JUDEȚUL CONSTANTA
				PROFIL LONGITUDINAL PISTA BICICLETE STANGA - TRASEU DUS

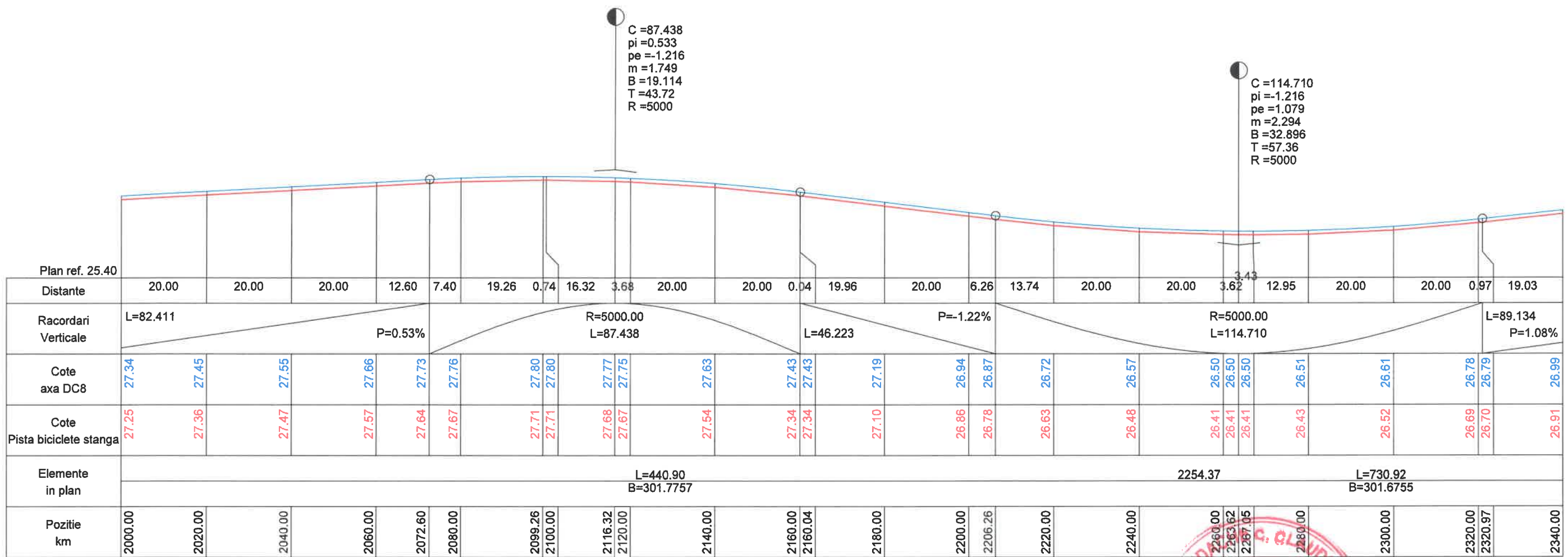

Verificator	Nume	Semnatura	Cerinta	Referat nr./data
Proiectant:	ENGINEERING			Beneficiar: COMUNA LIMANU, JUDEȚUL CONSTANȚA
1ENGINEERING SRL • RO28725629 • J13/1567/2011 • CONSTANȚA, B-CUL TOMIS, NR.143A				Proiect nr. 241/2024
Sef proiect	ing.Sorin PANA	<i>[Signature]</i>	Scara 1:1000 / 1:100	Faza: P.T.+D.E.
Proiectat	ing.Andreea ANTOHI	<i>[Signature]</i>	Data APRILIE 2024	Plansa nr. L2.02
Verificat	ing.Sorin PANA	<i>[Signature]</i>		



C = 156.736
 pi = 3.285
 pe = -0.633
 m = 3.918
 B = 76.769
 T = 78.37
 R = 4000

C = 50.369
 pi = 3.915
 pe = 3.285
 m = 0.630
 B = 3.964
 T = 25.18
 R = 8000

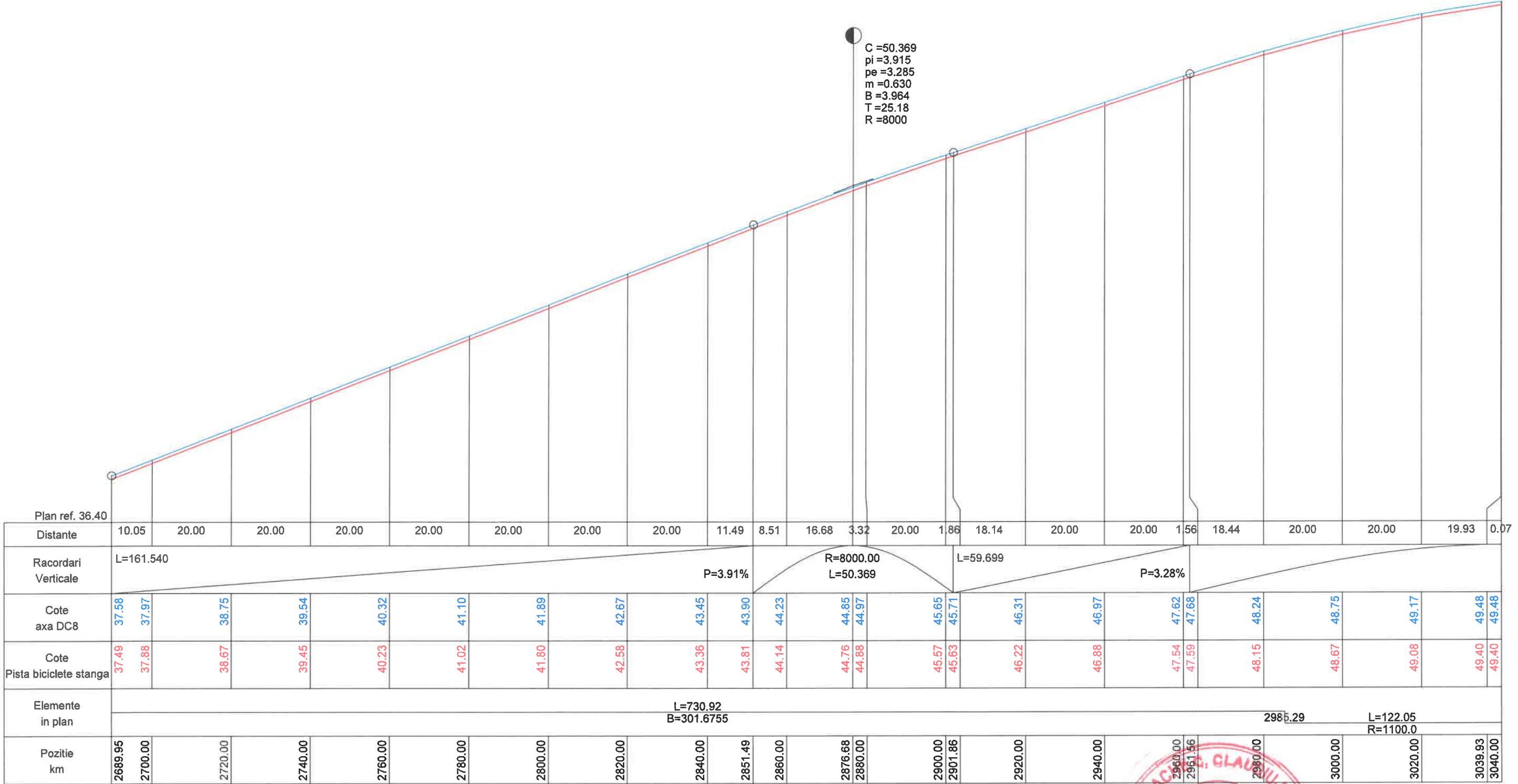

Verificator	Nume	Semnatura	Cerinta	Referat nr./data
Proiectant:	INGINEERING			Beneficiar: COMUNA LIMANU, JUDEȚUL CONSTANȚA
INGINEERING SRL • RO28725629 • J13/1567/2011 • CONSTANȚA, B-DUL TOMIS, NR.143A				Proiect nr. 241/2024
Sef proiect	ing.Sorin PANA	<i>[Signature]</i>	Scara 1:1000 /1:100	Faza: P.T.+D.E.
Proiectat	ing.Andreea ANTOHI	<i>[Signature]</i>	Data APRILIE 2024	Plansa nr. L2.04
Verificat	ing.Sorin PANA	<i>[Signature]</i>		

ASIGURAREA INFRASTRUCTURII PENTRU TRANSPORT VERDE - PISTA DE BICICLETE IN COMUNA LIMANU, JUDEȚUL CONSTANȚA

PROFIL LONGITUDINAL PISTA BICICLETE STANGA - TRASEU DUS

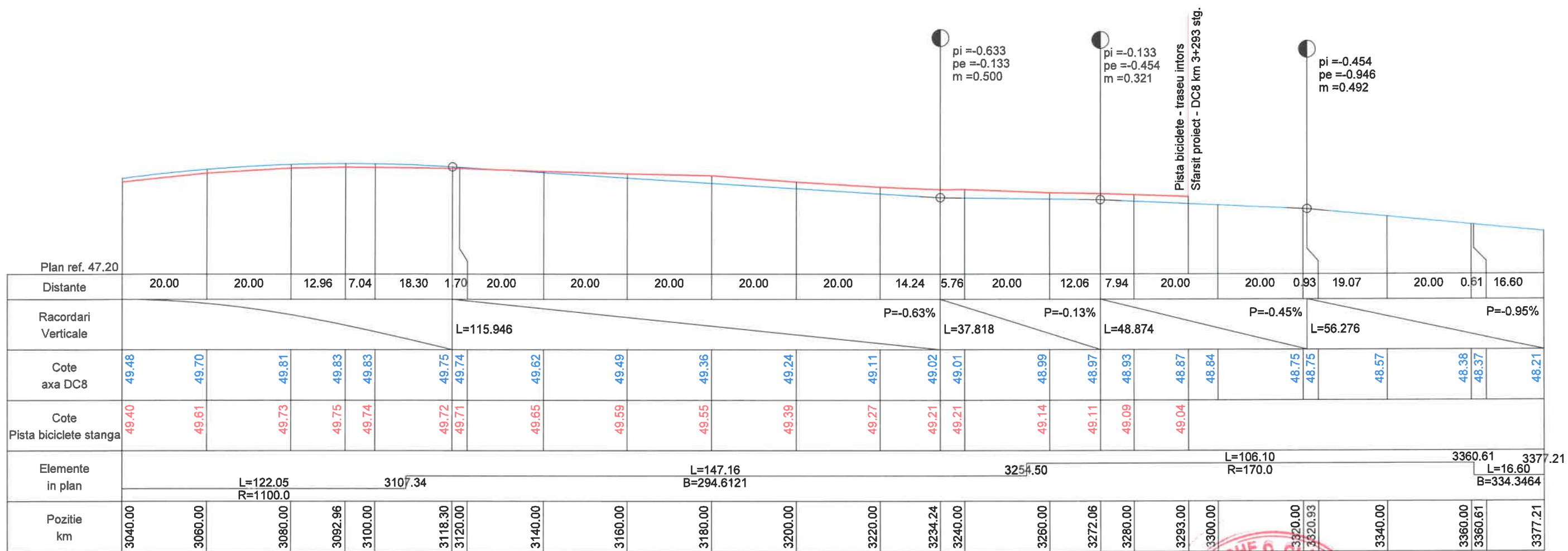

Verificator	Nume	Semnatura	Cerinta	Referat nr./data
Proiectant:	1ENGINEERING		Beneficiar:	COMUNA LIMANU, JUDEȚUL CONSTANȚA
1ENGINEERING SRL • RO28725629 • J13/1567/2011 • CONSTANTA, B-DUL TOMIS, NR.143A			Scara	ASIGURAREA INFRASTRUCTURII PENTRU TRANSPORT VERDE - PISTA DE BICICLETE IN COMUNA LIMANU, JUDEȚUL CONSTANTA
Sef proiect	ing.Sorin PANA	<i>[Signature]</i>	1:1000 / 1:100	Faza: P.T.+D.E.
Proiectat	ing.Andreea ANTOHI	<i>[Signature]</i>	Data	PROFIL LONGITUDINAL PISTA BICICLETE STANGA - TRASEU DUS
Verificat	ing.Sorin PANA	<i>[Signature]</i>	APRILIE 2024	Plansa nr. L2.05



PROFIL TRANSVERSAL TIP 01

Scara 1:50

Sectiuni transversale piste biciclete

Se aplica pe: DC8 km 1+642 - km 1+759, km 1+799 - km 1+804, km 1+997 - km2+164;
km 2+191 - km 2+196, km 2+222 - km 2+230; km 2+250 - km 2+318;
km 2+367 - km 2+376; km 2+425 - km 2+446; km 2+849 - km 3+159;
km 3+204 - km 3+293

Pista de biciclete - traseu intors

Pista de biciclete - traseu dus

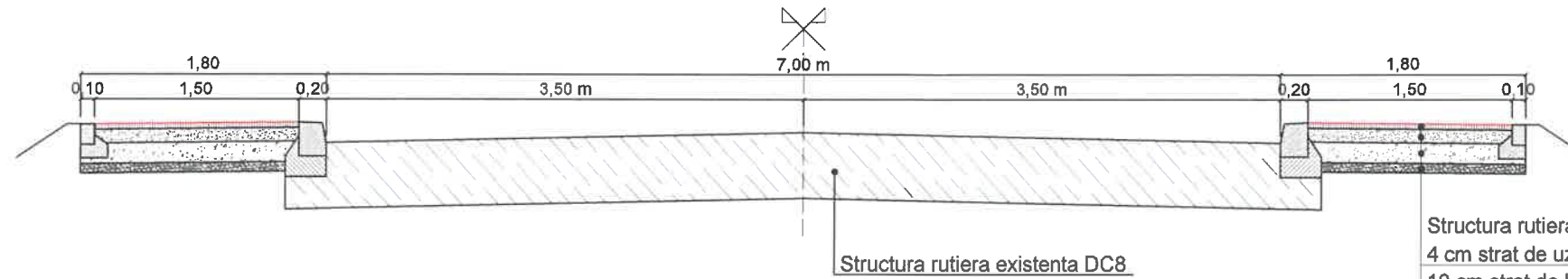

Structura rutiera pista biciclete:
4 cm strat de uzura din beton asfaltic BA16 rul50/70
10 cm strat de baza din macadam
15 cm strat de fundatie din piatra sparta
7 cm strat suport de nisip

PROFIL TRANSVERSAL TIP 02

Scara 1:50

Sectiuni transversale piste biciclete

Se aplica pe: DC8 km 1+759 - km 1+799, km 1+844 - km 1+875, km 2+318 - km 2+367

Pista de biciclete - traseu intors

Statie transport in comun

Pista de biciclete - traseu dus

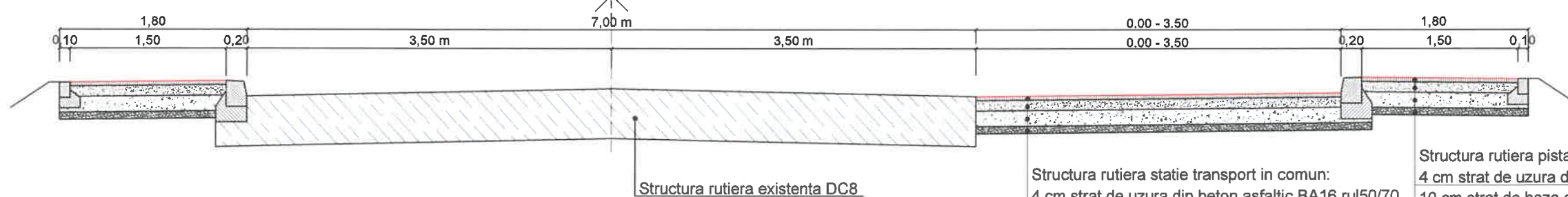

Structura rutiera statie transport in comun:
4 cm strat de uzura din beton asfaltic BA16 rul50/70
10 cm strat de baza din macadam
15 cm strat de fundatie din piatra sparta
7 cm strat suport de nisip

Structura rutiera pista biciclete:
4 cm strat de uzura din beton asfaltic BA16 rul50/70
10 cm strat de baza din macadam
15 cm strat de fundatie din piatra sparta
7 cm strat suport de nisip

PROFIL TRANSVERSAL TIP 03

Scara 1:50

Sectiuni transversale piste biciclete

Se aplica pe: DC8 km 1+804 - km 1+844, km 2+413 - km 2+425, km 3+159 - km 3+204

Pista de biciclete - traseu intors

Statie transport in comun

Pista de biciclete - traseu dus

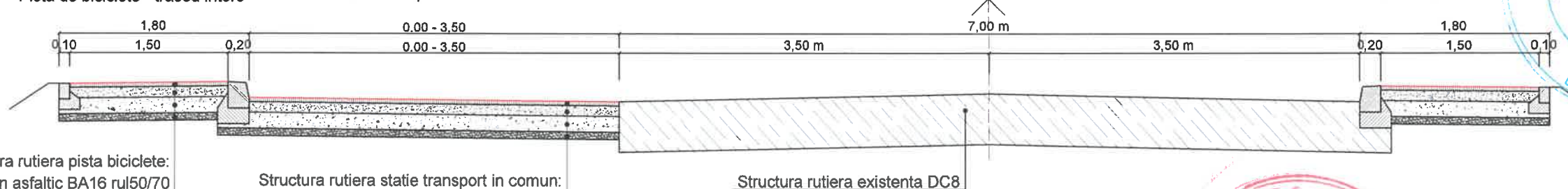

Structura rutiera pista biciclete:
4 cm strat de uzura din beton asfaltic BA16 rul50/70
10 cm strat de baza din macadam
15 cm strat de fundatie din piatra sparta
7 cm strat suport de nisip

Structura rutiera statie transport in comun:
4 cm strat de uzura din beton asfaltic BA16 rul50/70
10 cm strat de baza din macadam
15 cm strat de fundatie din piatra sparta
7 cm strat suport de nisip

Structura rutiera existenta DC8



Verificator	Nume	Semnatura	Cerinta	Referat nr./data
Proiectant:	1 ENGINEERING		Beneficiar:	COMUNA LIMANU, JUDEȚUL CONSTANȚA
1ENGINEERING SRL • RO28725629 • J13/1567/2011 • CONSTANTA, B-DUL TOMIS, NR.143A			Scara	Faza:
			1:50	P.T.+D.E.
Sef proiect	ing.Sorin PANA	<i>[Signature]</i>	Date	ASIGURAREA INFRASTRUCTURII PENTRU TRANSPORT VERDE - PISTA DE BICICLETE IN COMUNA LIMANU, JUDEȚUL CONSTANTA
Proiectat	ing.Andreea ANTOHI	<i>[Signature]</i>	Date	SECTIUNI TRANSVERSALE TIP TRASEE PISTE BICICLETE
Verificat	ing.Sorin PANA	<i>[Signature]</i>	APRILIE 2024	Plansa nr. Tip.01

PROFIL TRANSVERSAL TIP 04
 Scara 1:50
 Sectiuni transversale piste biciclete
 Se aplica pe: DC8 km 1+875 - km 1+965

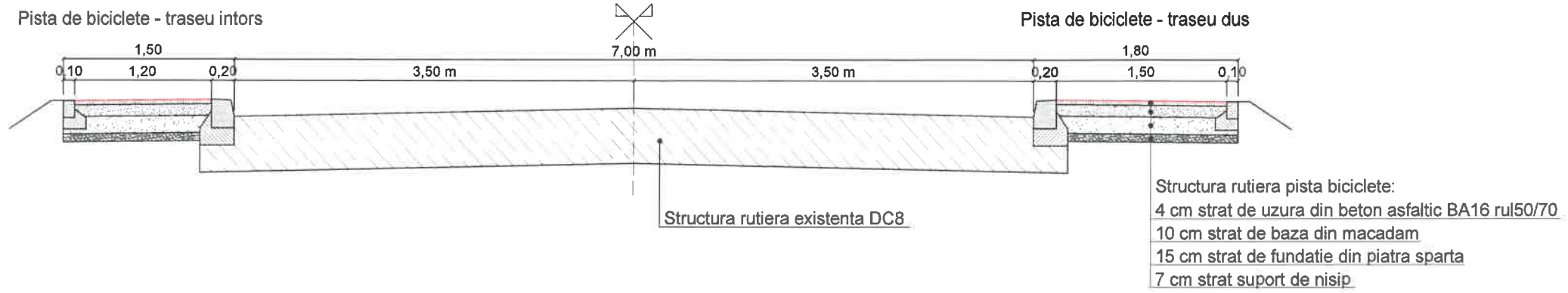

PROFIL TRANSVERSAL TIP 05
 Scara 1:50
 Sectiuni transversale piste biciclete
 Se aplica pe: DC8 km 1+965 - km 1+997

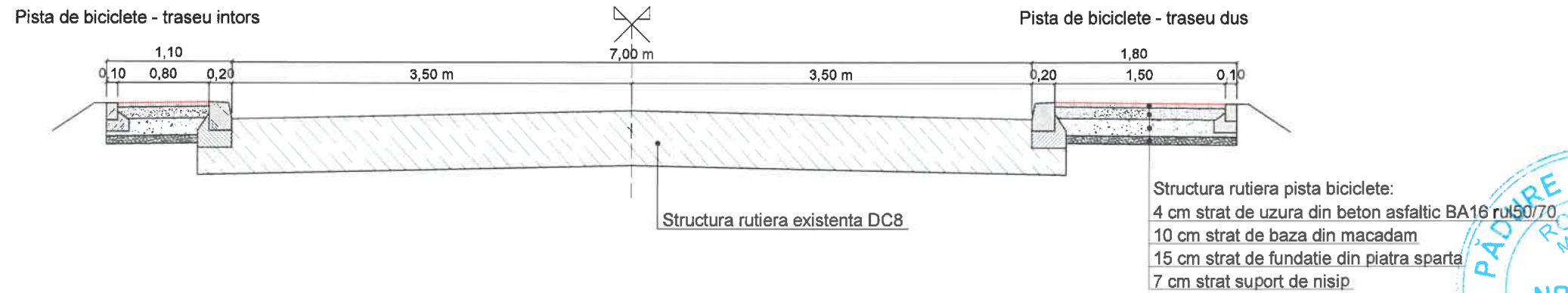

PROFIL TRANSVERSAL TIP 06
 Scara 1:50
 Sectiuni transversale piste biciclete
 Se aplica pe: DC8 km 2+164 - km 2+191, km 2+196 - km 2+202

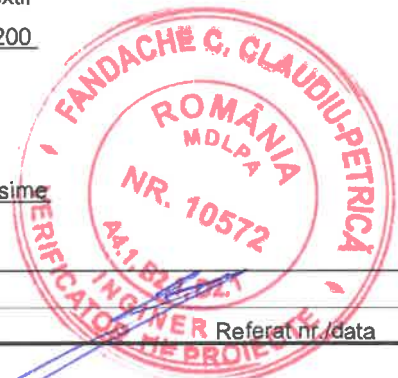
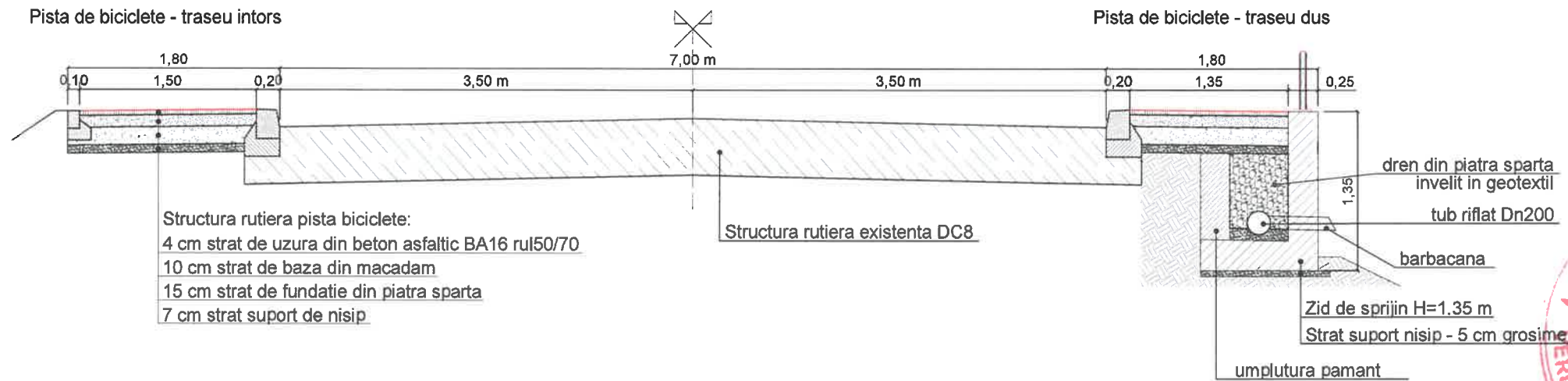

Verificator	Nume	Semnatura	Cerinta	Referat nr./data	
Proiectant:	1ENGINEERING			Beneficiar:	Proiect nr. 241/2024
1ENGINEERING SRL • RO28725629 • J13/1567/2011 • CONSTANTA, B-DUL TOMIS, NR.143A				COMUNA LIMANU, JUDEȚUL CONSTANȚA	
Sef proiect	ing.Sorin PANA		Scara 1:50	ASIGURAREA INFRASTRUCTURII PENTRU TRANSPORT VERDE - PISTA DE BICICLETE IN COMUNA LIMANU, JUDEȚUL CONSTANTA	
Proiectat	ing.Andreea ANTOHI		Data	SECTIUNI TRANSVERSALE TIP TRASEE PISTE BICICLETE	
Verificat	ing.Sorin PANA		APRILIE 2024	Plansa nr. Tip.02	

PROFIL TRANSVERSAL TIP 07
 Scara 1:50
 Sectiuni transversale piste biciclete
 Se aplica pe: DC8 km 2+202 - km 2+222, km 2+230 - km 2+245

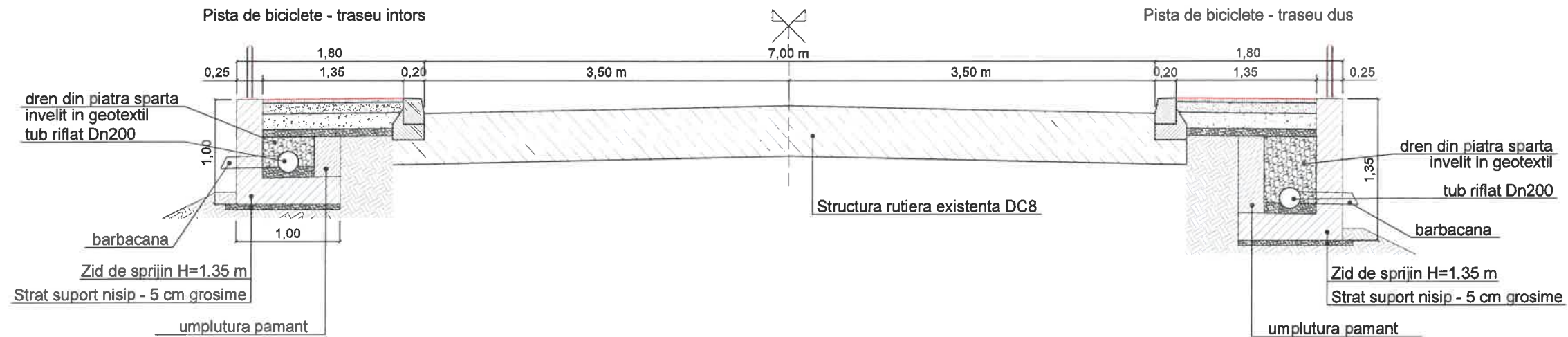

PROFIL TRANSVERSAL TIP 08
 Scara 1:50
 Sectiuni transversale piste biciclete
 Se aplica pe: DC8 km 2+245 - km 2+250

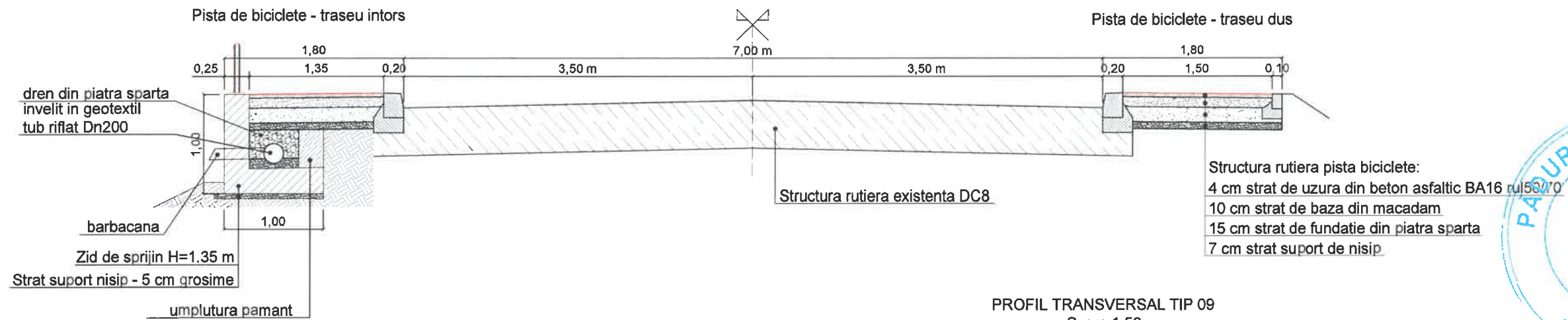

PROFIL TRANSVERSAL TIP 09
 Scara 1:50
 Sectiuni transversale piste biciclete
 Se aplica pe: DC8 km 2+376 - km 2+413

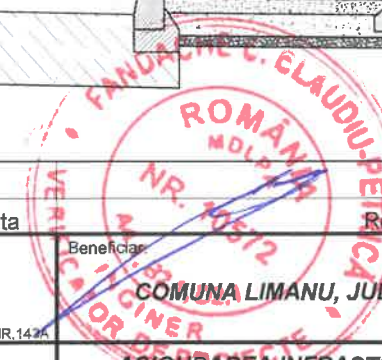
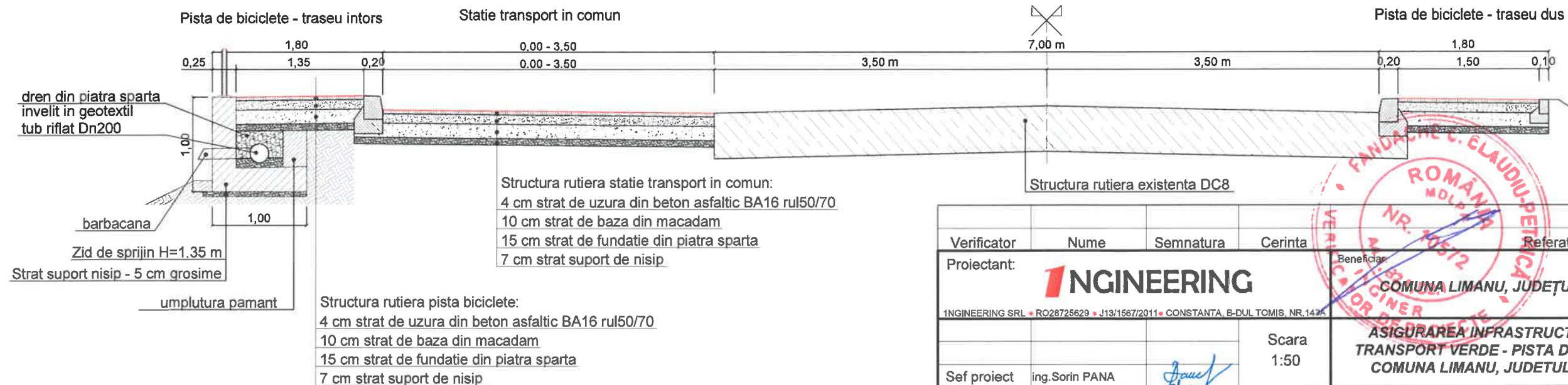

Verificator	Nume	Semnatura	Cerinta	Referat nr./data
Proiectant:	1ENGINEERING		Beneficiar:	COMUNA LIMANU, JUDEȚUL CONSTANȚA
	1ENGINEERING SRL • RO28725629 • J13/1567/2011 • CONSTANTA, B-DUL TOMIS, NR.142A		Scara	ASIGURAREA INFRASTRUCTURII PENTRU TRANSPORT VERDE - PISTA DE BICICLETE IN COMUNA LIMANU, JUDEȚUL CONSTANTA
Sef proiect	ing.Sorin PANA	<i>[Signature]</i>	1:50	Faza: P.T.+D.E.
Proiectat	ing.Andreea ANTOHI	<i>[Signature]</i>	Data	SECTIUNI TRANSVERSALE TIP TRASEE PISTE BICICLETE
Verificat	ing.Sorin PANA	<i>[Signature]</i>	APRILIE 2024	

PROFIL TRANSVERSAL TIP 10
 Scara 1:50
 Sectiuni transversale piste biciclete
 Se aplica pe: DC8 km 2+446 - km 2+648

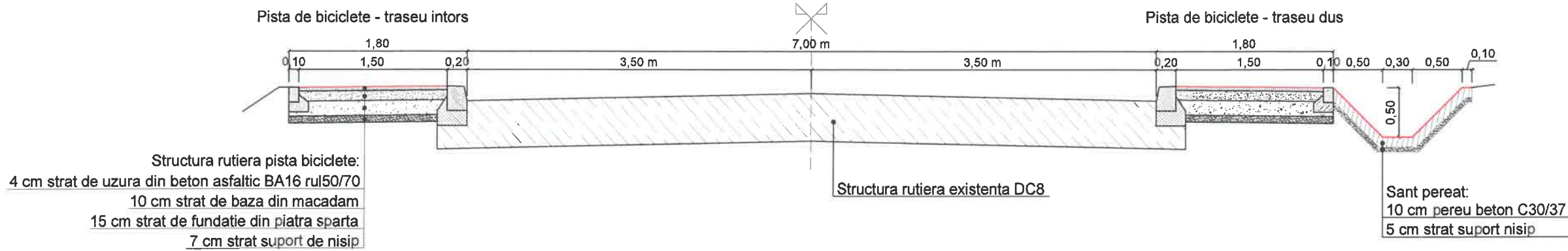

PROFIL TRANSVERSAL TIP 11
 Scara 1:50
 Sectiuni transversale piste biciclete
 Se aplica pe: DC8 km 2+648 - km 2+849

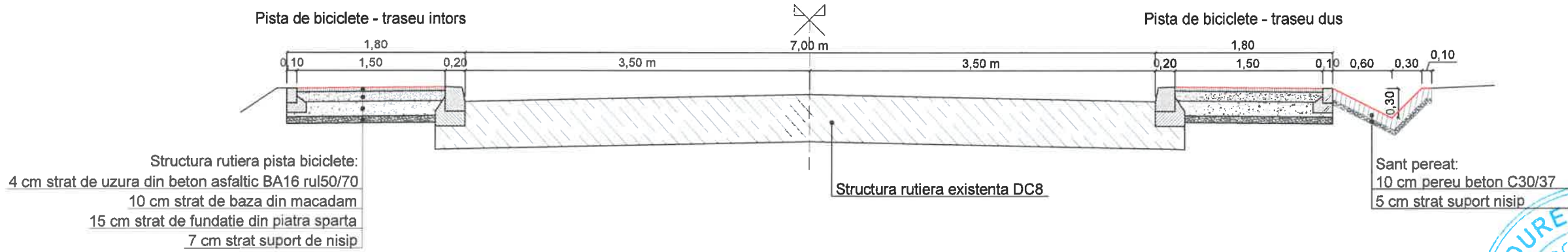

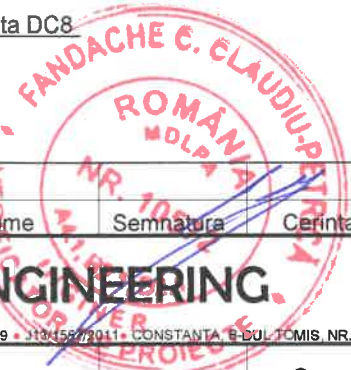
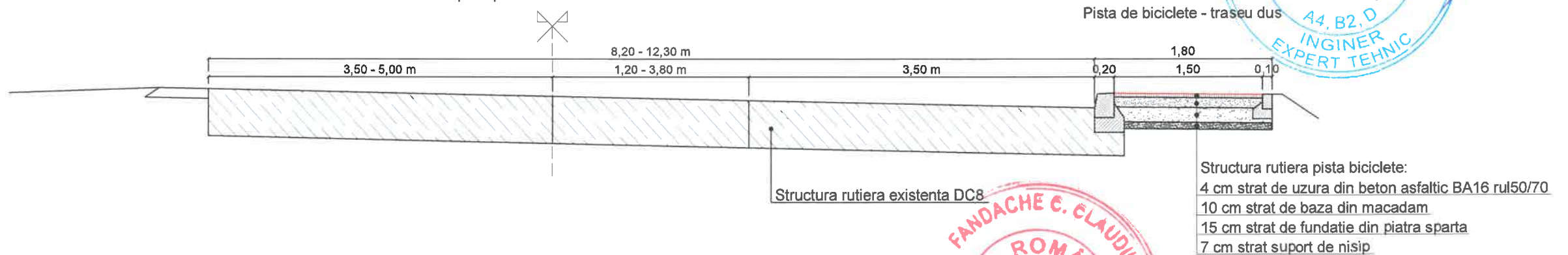

PROFIL TRANSVERSAL TIP 12
 Scara 1:50
 Sectiune transversala pista biciclete
 Se aplica pe: DC8 km 3+293 - km 3+338

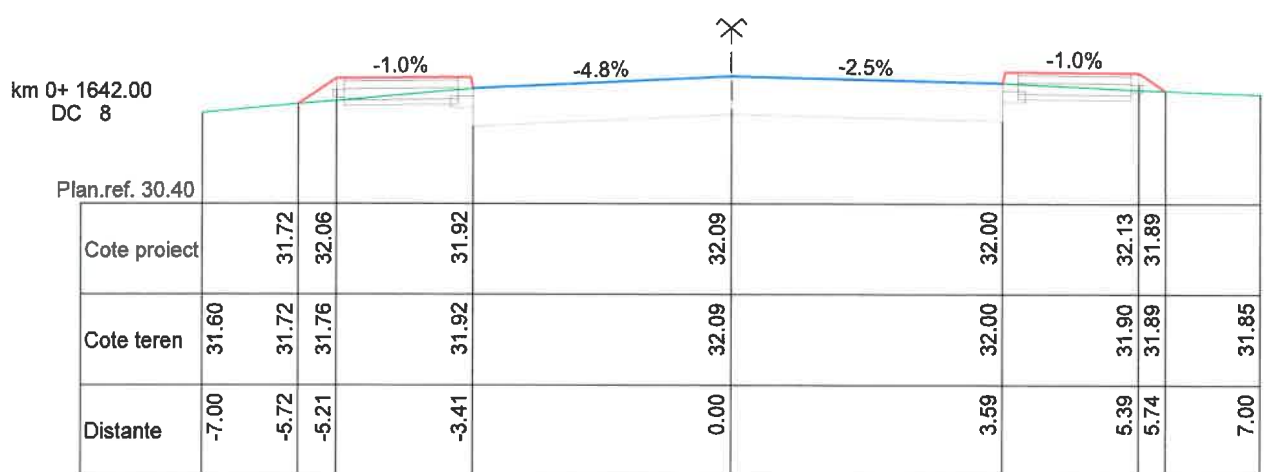
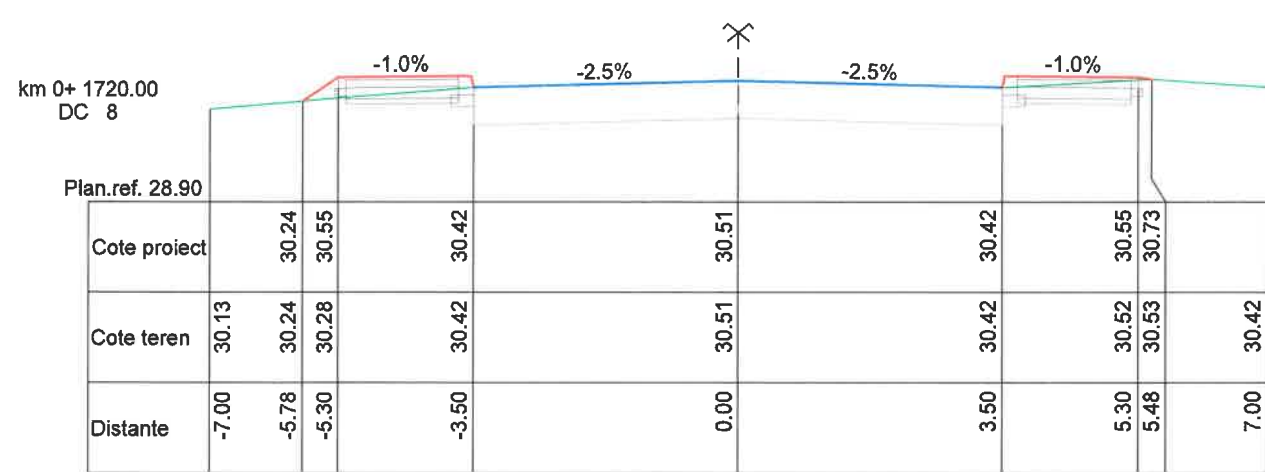
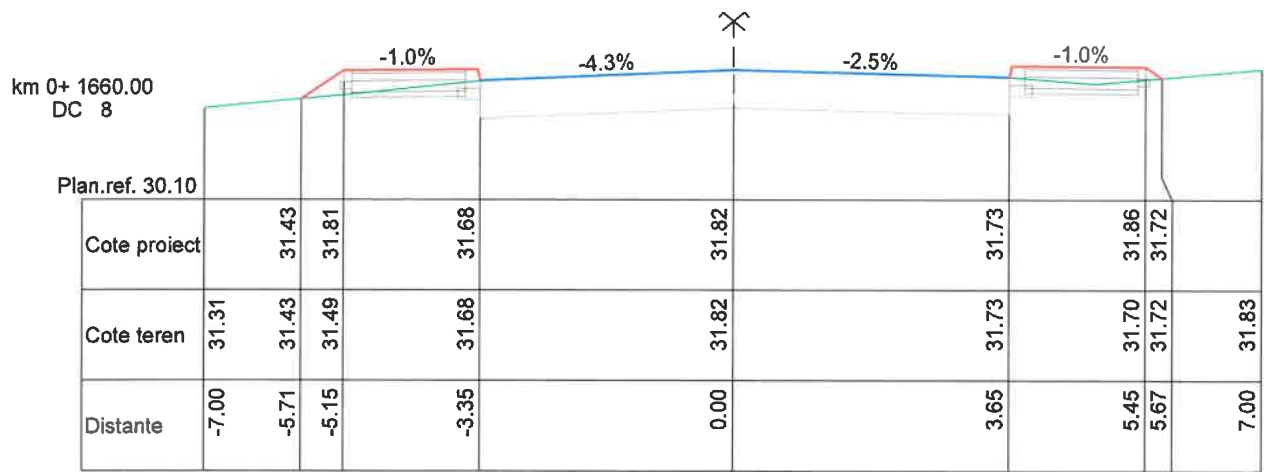
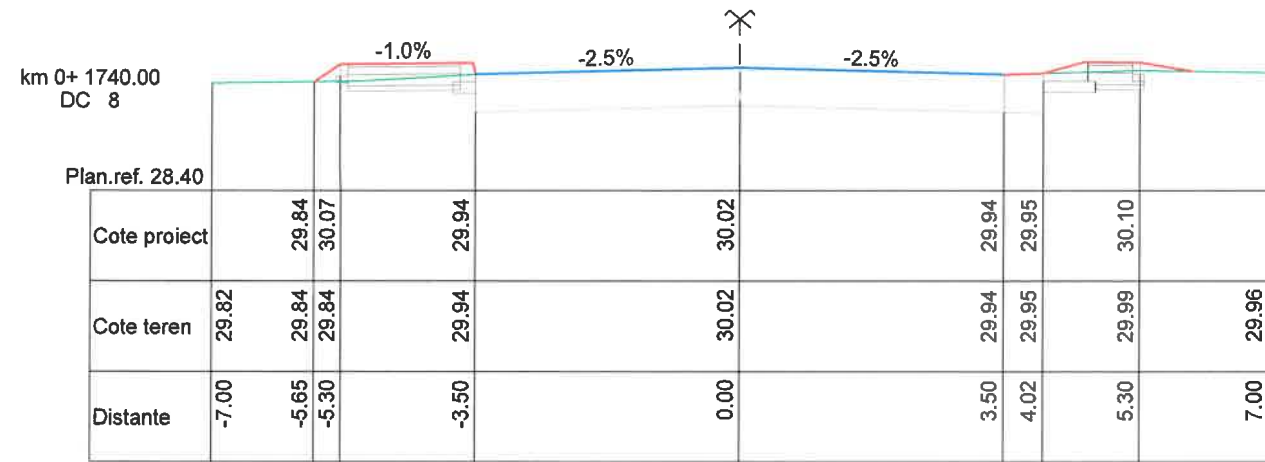
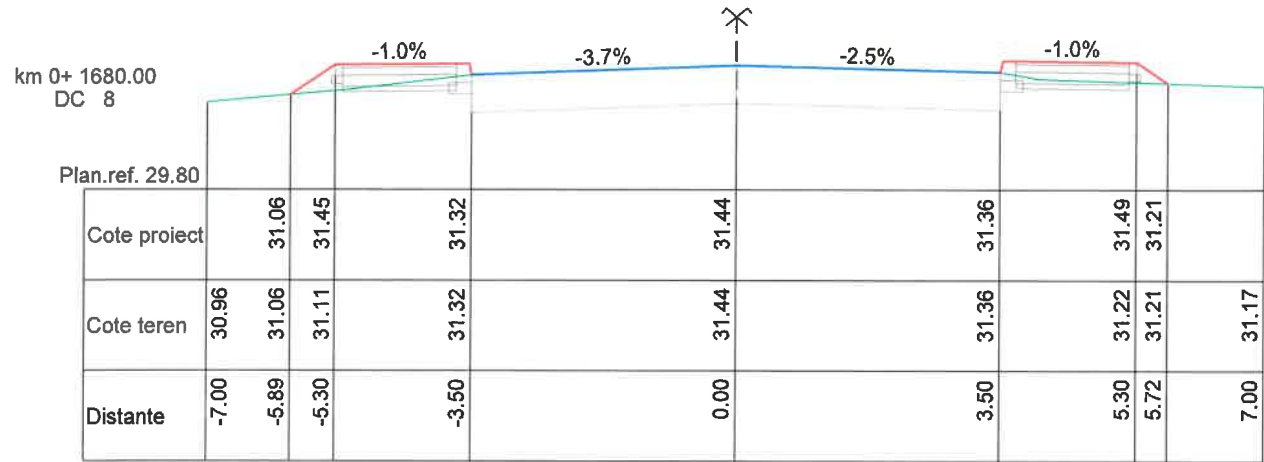
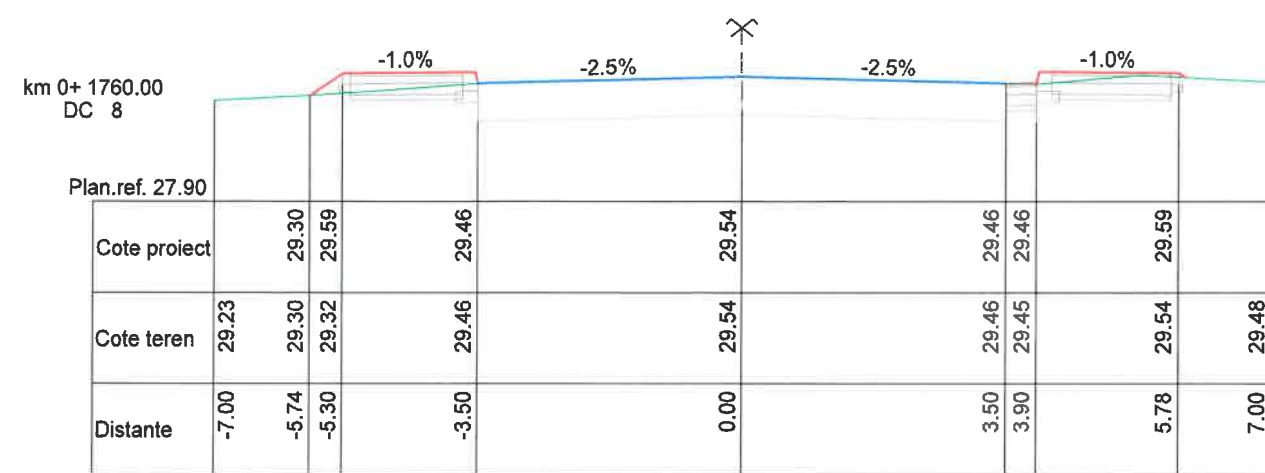
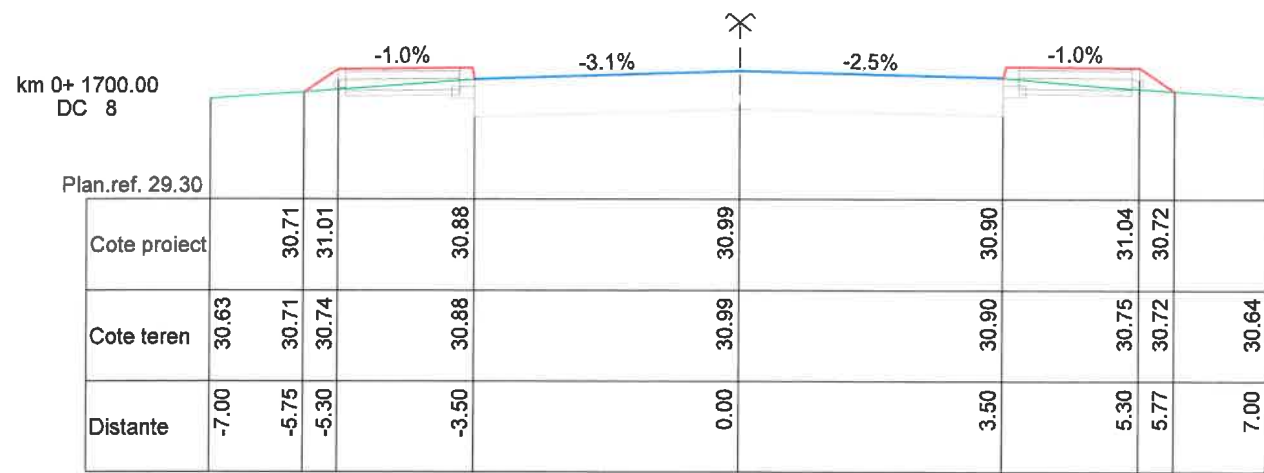

Verificator	Nume	Semnatura	Cerinta	Referat nr./data	
Proiectant:				Beneficiar:	Proiect nr.
	INGINEERING SRL • RO28725629 • J13/158/2011 • CONSTANTA, B-DUL TOMIS, NR.143A			COMUNA LIMANU, JUDEȚUL CONSTANȚA	241/2024
Sef proiect	ing.Sorin PANA		Scara 1:50	Faza: P.T.+D.E.	
Proiectat	ing.Andreea ANTOHI		Data	ASIGURAREA INFRASTRUCTURII PENTRU TRANSPORT VERDE - PISTA DE BICICLETE IN COMUNA LIMANU, JUDEȚUL CONSTANTA	
Verificat	ing.Sorin PANA		APRILIE 2024	SECTIUNI TRANSVERSALE TIP TRASEE PISTE BICICLETE	
				Plansa nr. Tip.04	

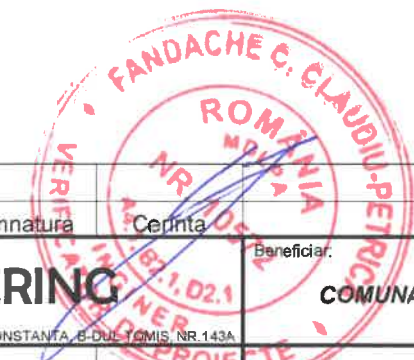

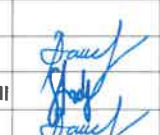

Verificator	Nume	Semnatura	Cerința	Referat nr./data
Proiectant:	1ENGINEERING			Beneficiar:
1ENGINEERING SRL • RO28725629 • J13/1567/2011 • CONSTANTA, B-DUL TOMIS, NR.143A				COMUNA LIMANU, JUDEȚUL CONSTANȚA
Scara 1:100				ASIGURAREA INFRASTRUCTURII PENTRU TRANSPORT VERDE - PISTA DE BICICLETE IN COMUNA LIMANU, JUDEȚUL CONSTANTA
Sef proiect	ing.Sorin PANA		Data	Faza: P.T.+D.E.
Proiectat	ing.Andreea ANTOHI		APRILIE 2024	Planșa nr. T.01
Verificat	ing.Sorin PANA			

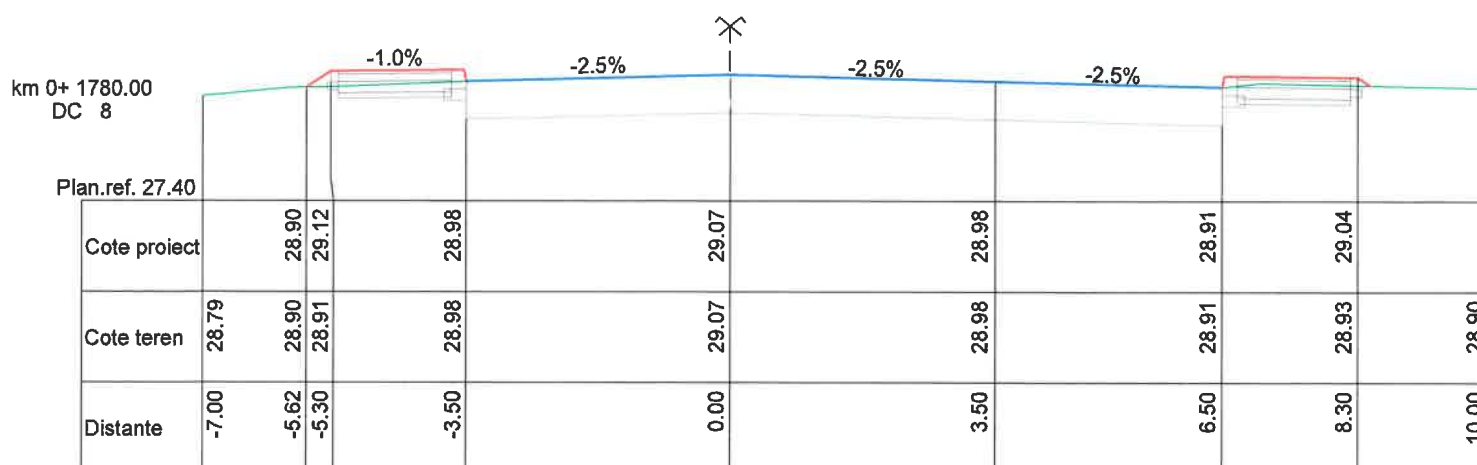
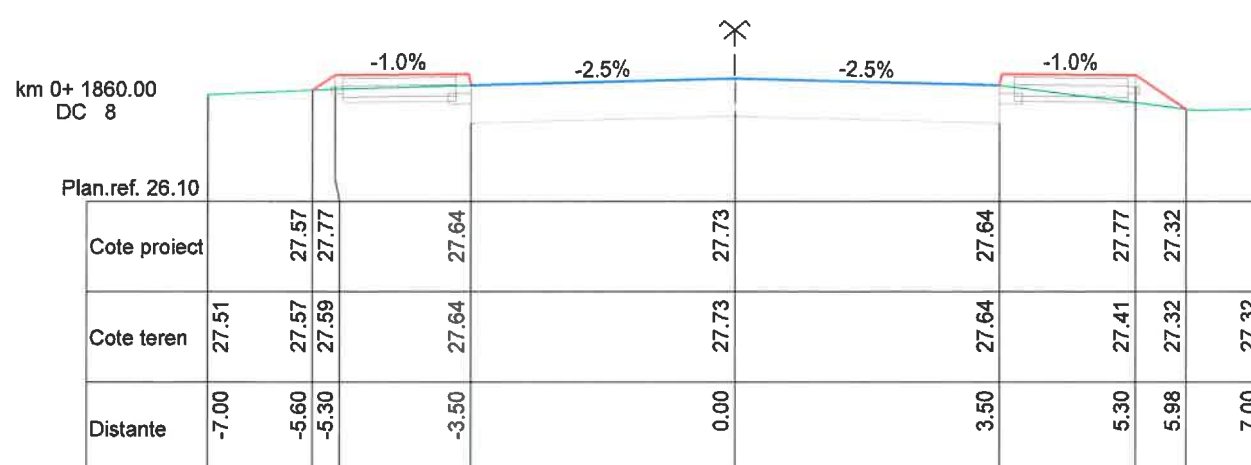
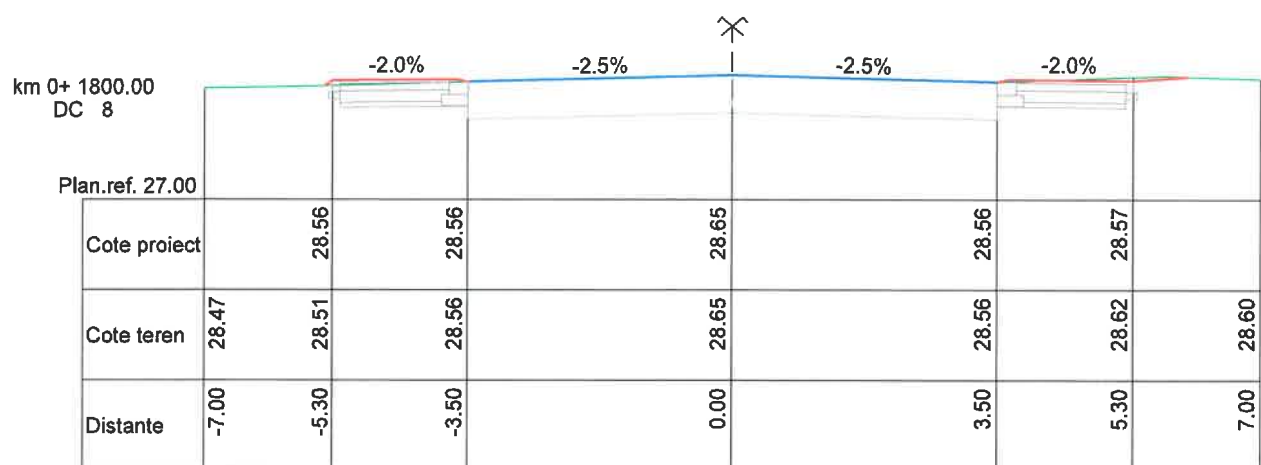
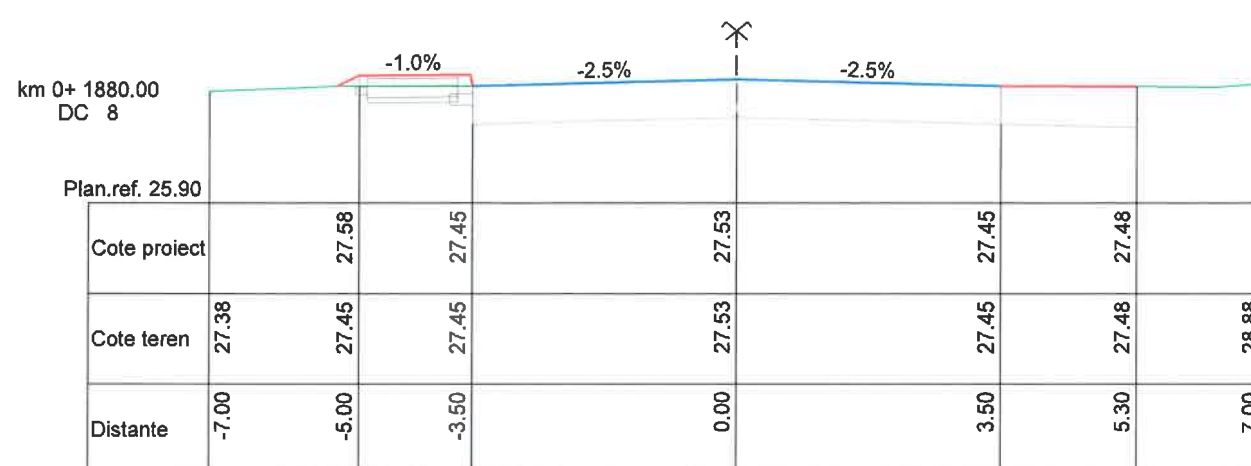
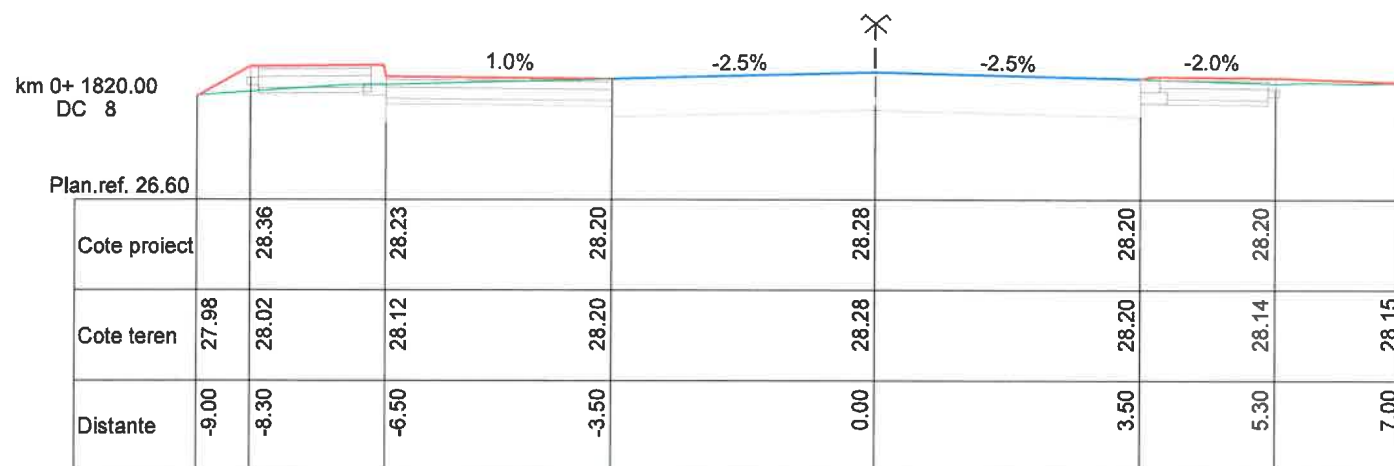
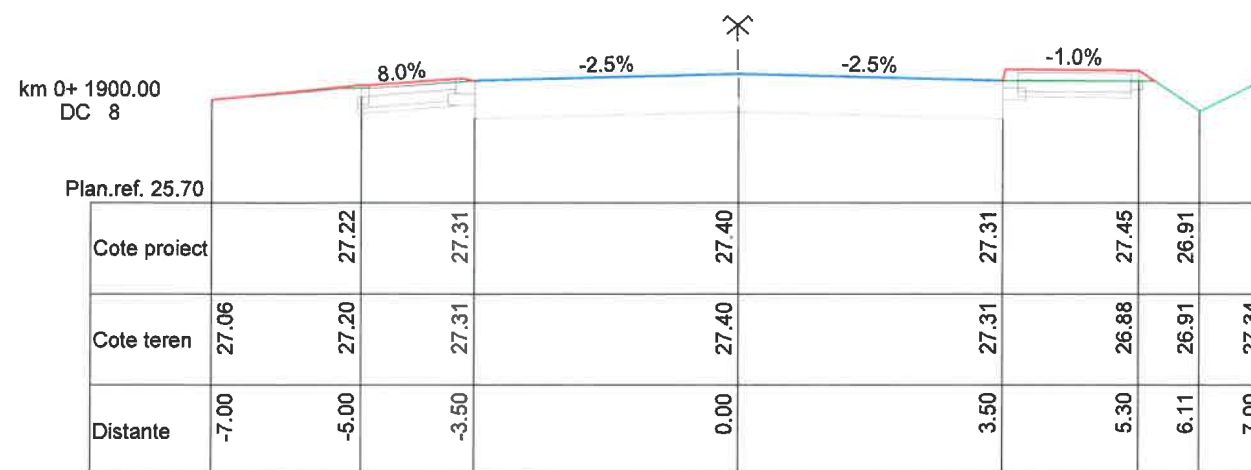

Verificator	Nume	Semnatura	Cerinta	Referat nr./data
Proiectant:	ENGINEERING		Beneficiar:	COMUNA LIMANU, JUDEȚUL CONSTANȚA
<small>ENGINEERING SRL • RO28725629 • J13/1567/2011 • CONSTANȚA, B-DUL TOMIS, NR. 143A</small>				Proiect nr. 241/2024
Sef proiect	ing.Sorin PANA		Scara 1:100	Faza: P.T.+D.E.
Proiectat	ing.Andreea ANTOHI		Data APRILIE 2024	Plansa nr. T.02
Verificat	ing.Sorin PANA			

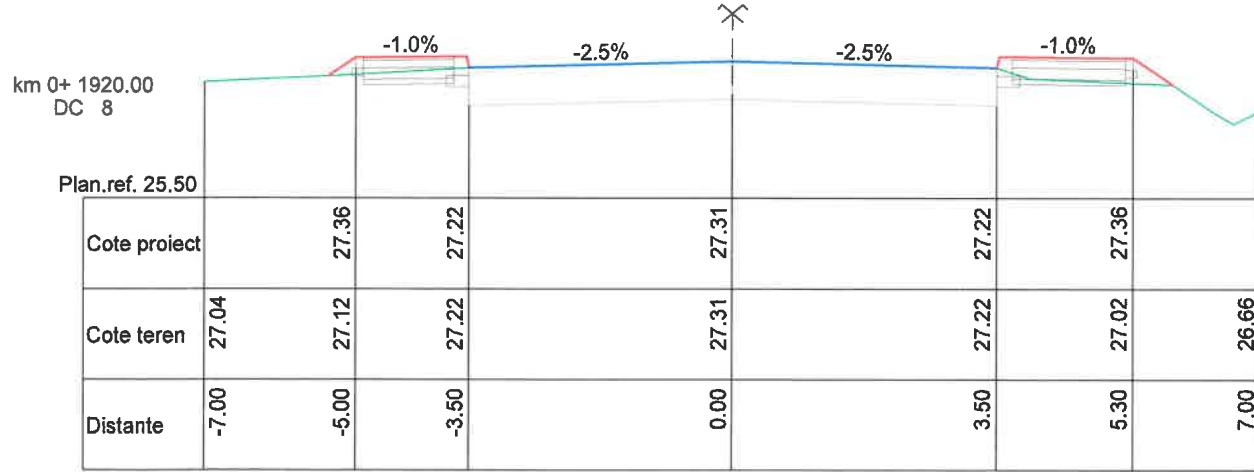
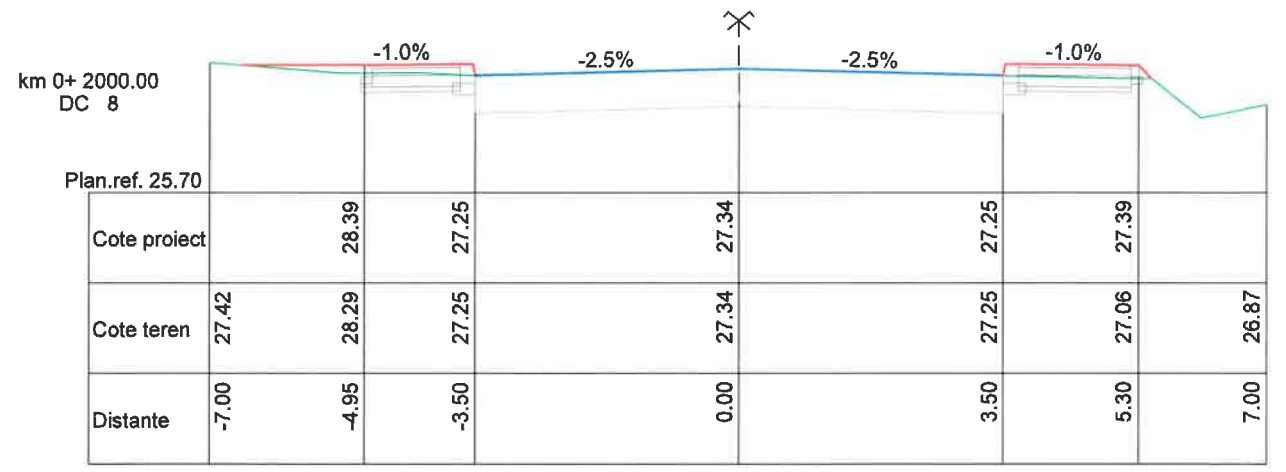
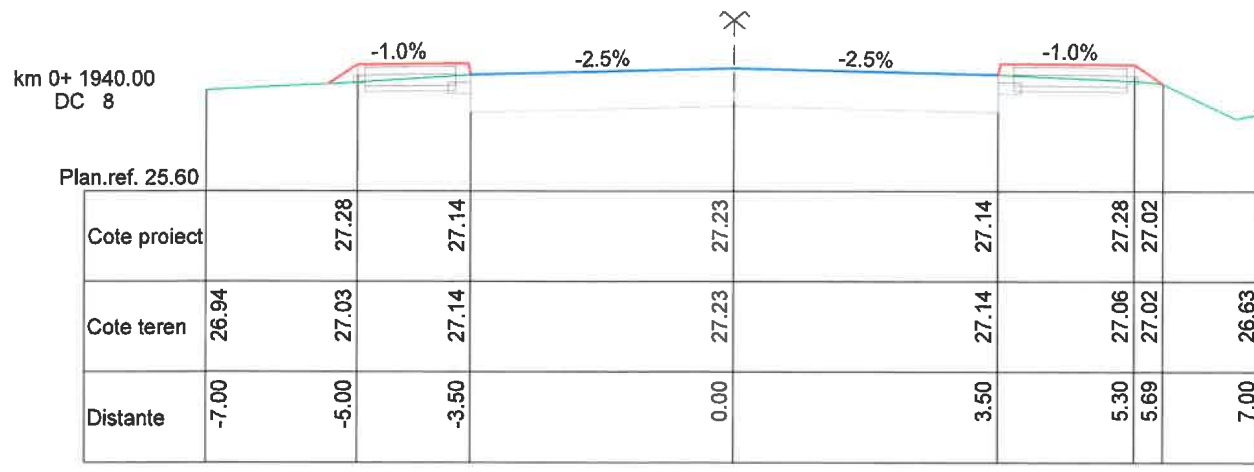
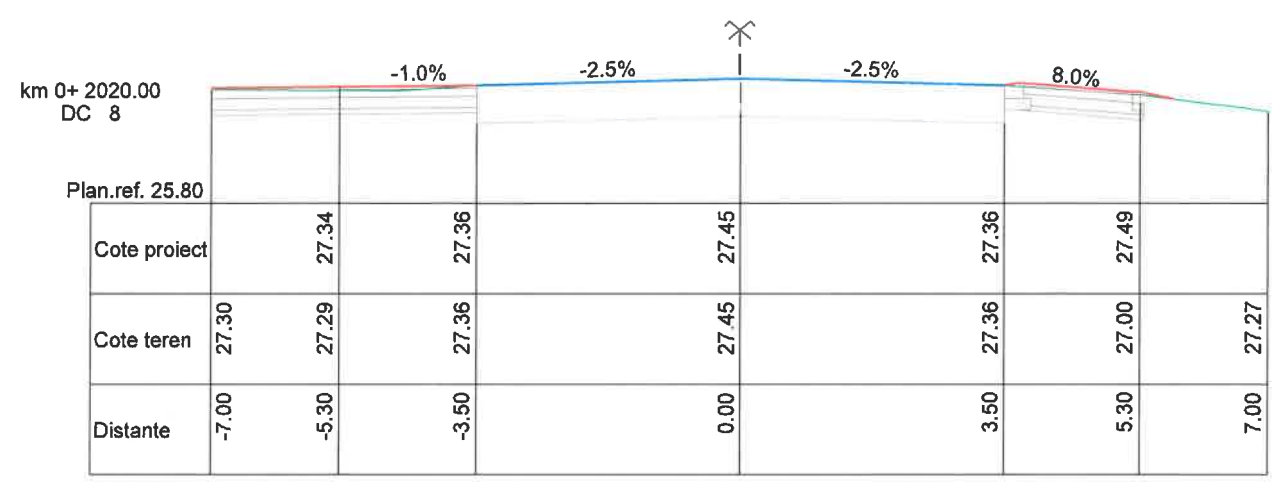
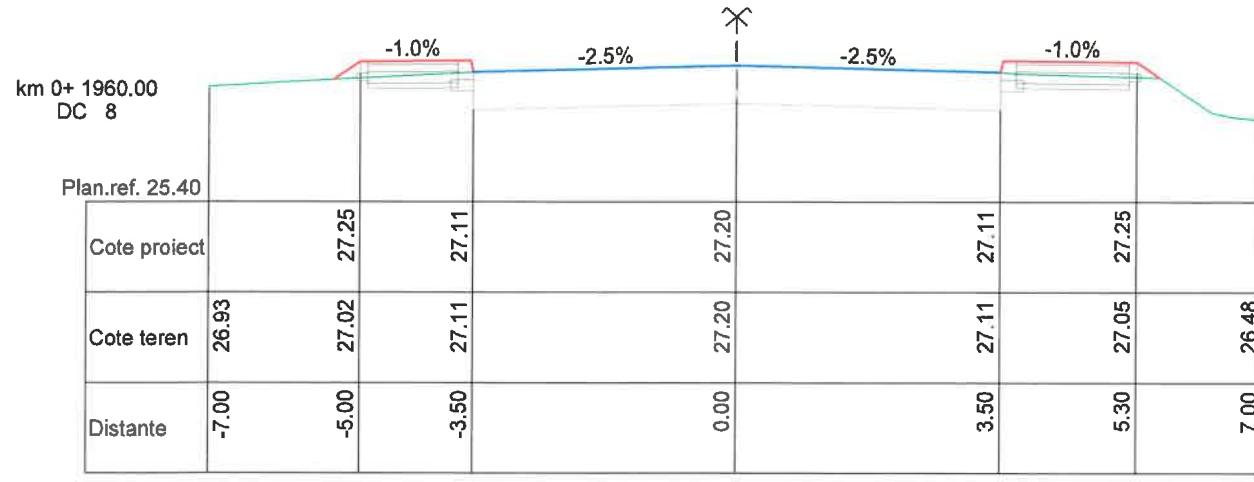
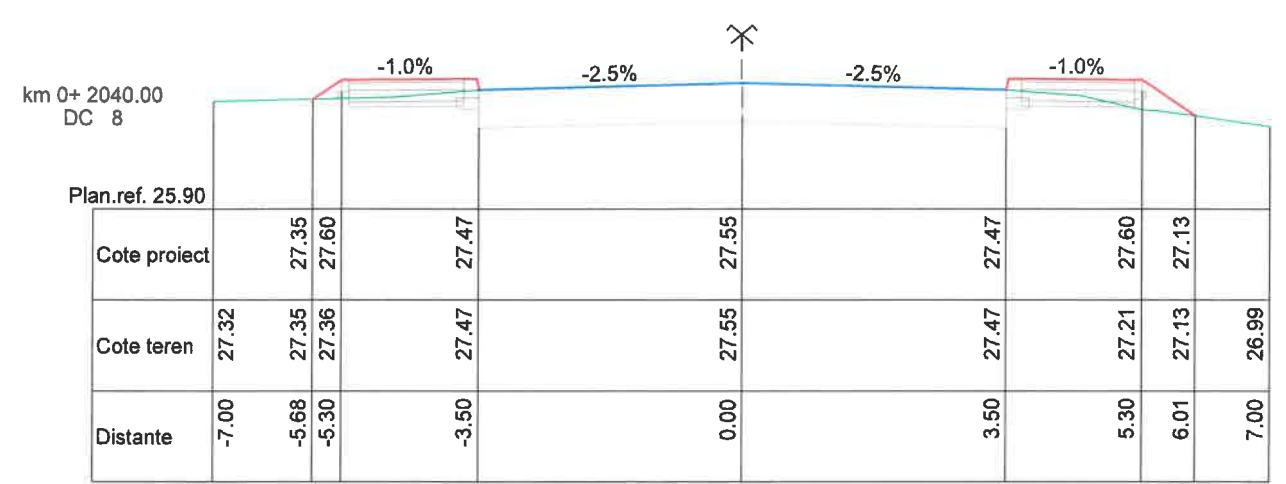
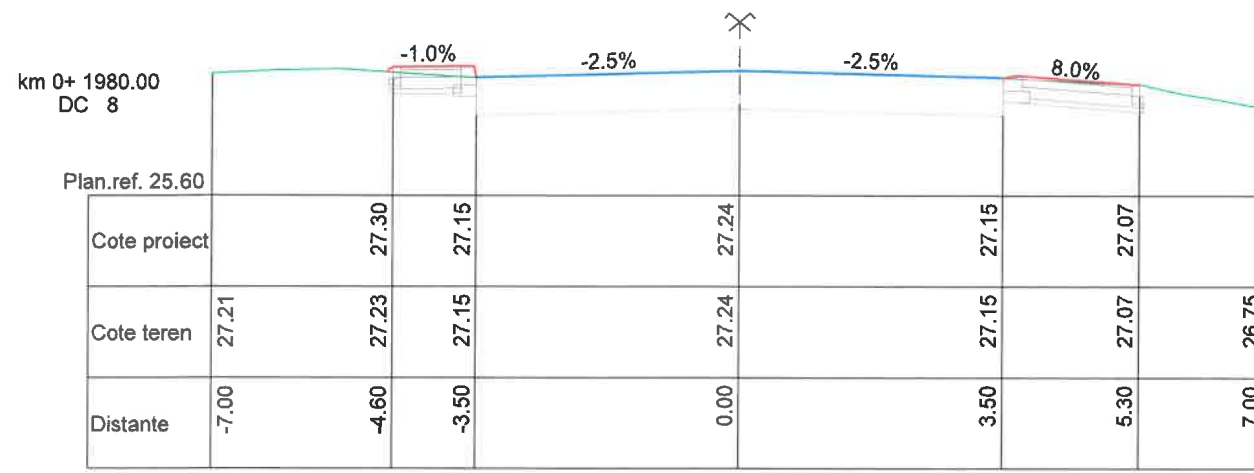

Verificator	Nume	Semnatura	Cerinta	Referat nr./data
Proiectant:				Beneficiar:
1ENGINEERING				COMUNA LIMANU, JUDEȚUL CONSTANȚA
1ENGINEERING SRL • RO28725829 • J13/1567/2011 • CONSTANTA • B-DUL TOMIS NR. 143A				Proiect nr. 241/2024
Scara 1:100				ASIGURAREA INFRASTRUCTURII PENTRU TRANSPORT VERDE - PISTA DE BICICLETE IN COMUNA LIMANU, JUDEȚUL CONSTANTA
Sef proiect	ing.Sorin PANA			Faza: P.T.+D.E.
Proiectat	ing.Andreea ANTOHI			
Verificat	ing.Sorin PANA		Data APRILIE 2024	Plansa nr. T.03
SECTIUNI TRANSVERSALE DC8 PISTA BICICLETE - TRASEU DUS - INTORS				

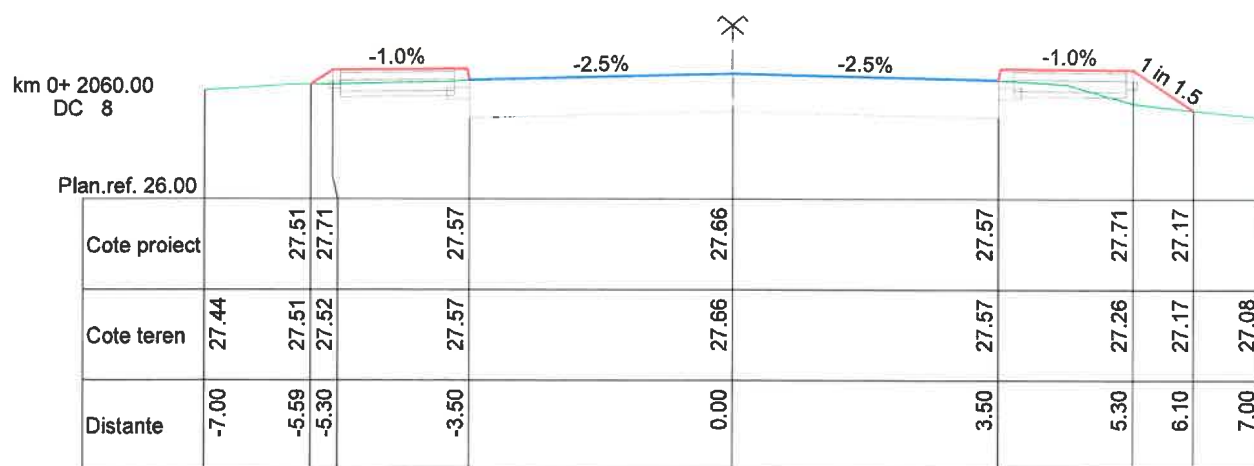
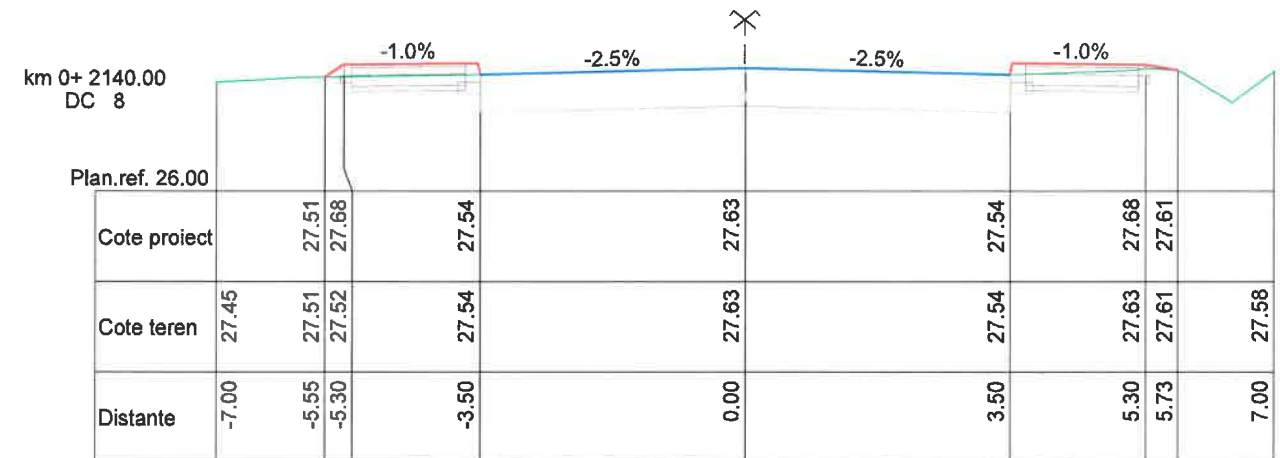
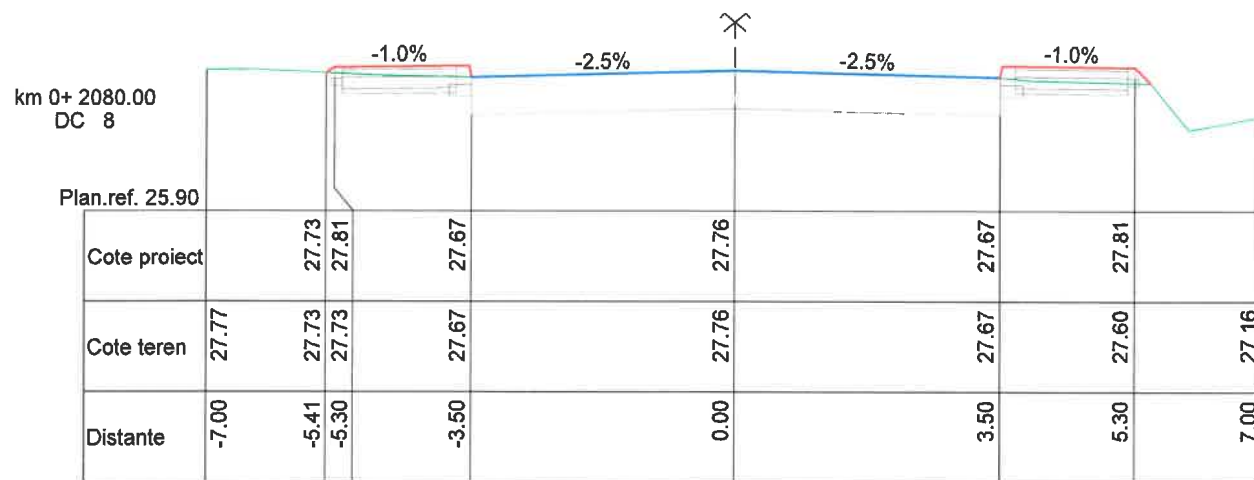
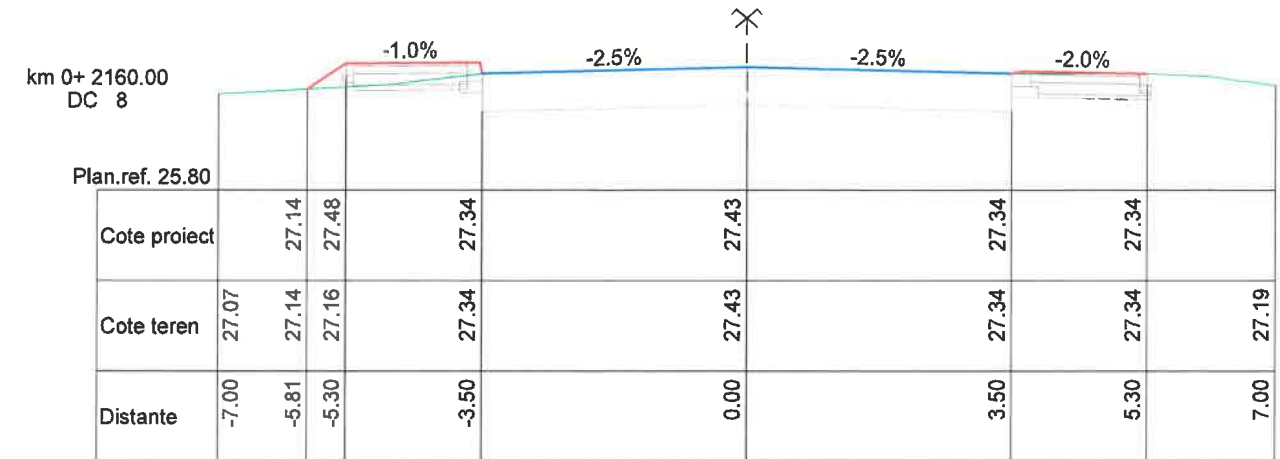
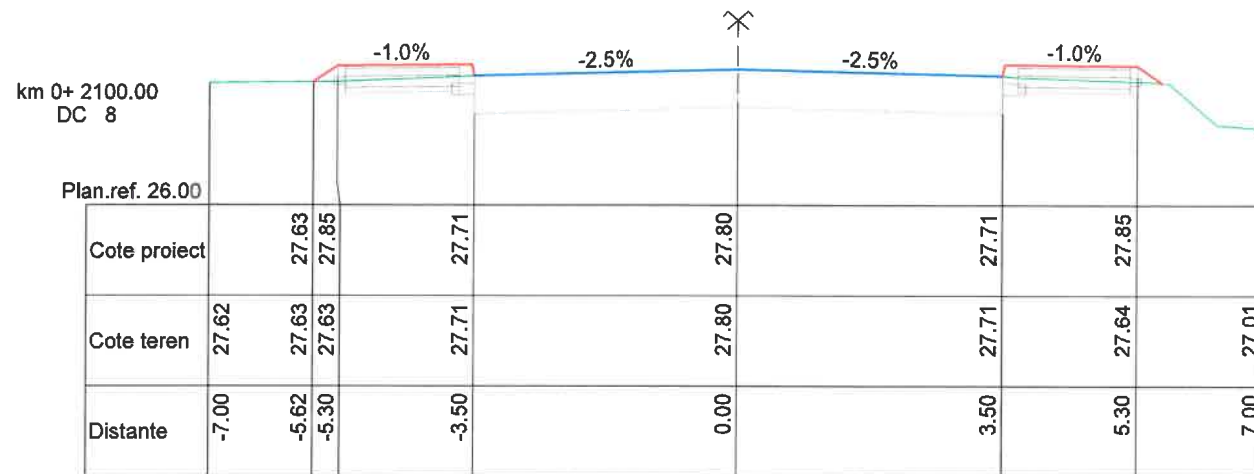
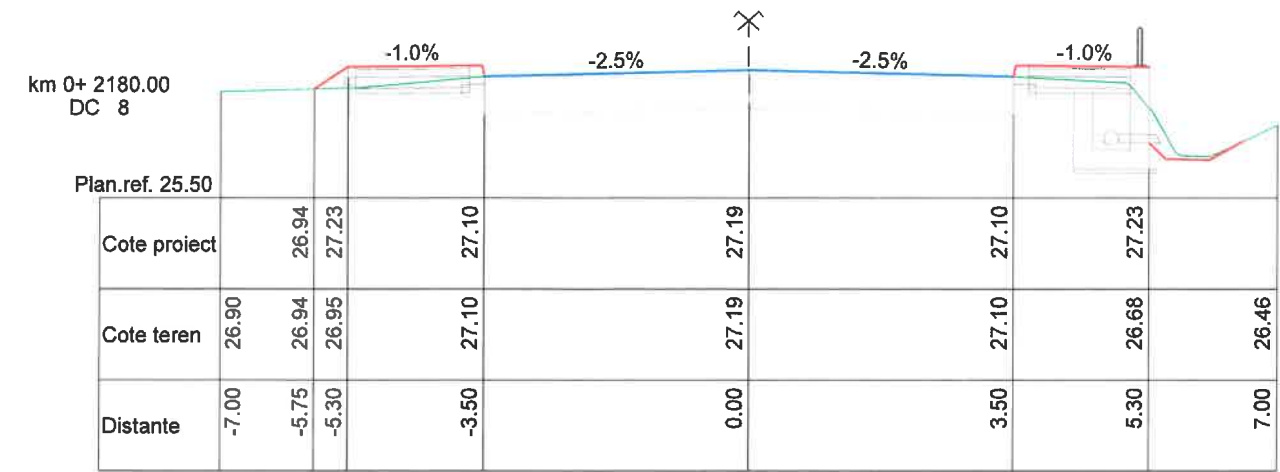
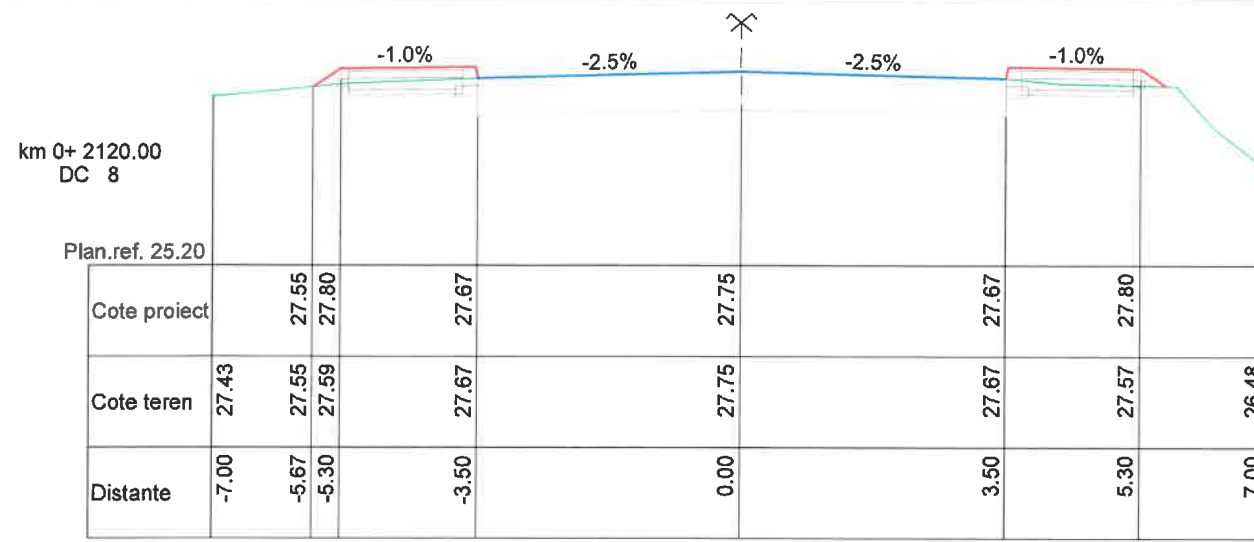

Verificator	Nume	Semnatura	Cerinta	Referat nr./data
Proiectant:	ENGINEERING		Beneficiar:	COMUNA LIMANU, JUDEȚUL CONSTANȚA
1ENGINEERING SRL • RO28725629 • J13/1567/2011 • CONSTANTA, B.DUL TOMIS, NR. 143A			Scara	ASIGURAREA INFRASTRUCTURII PENTRU TRANSPORT VERDE - PISTA DE BICICLETE IN COMUNA LIMANU, JUDEȚUL CONSTANTA
Sef proiect	ing.Sorin PANA		1:100	Faza: P.T.+D.E.
Proiectat	ing.Andreea ANTOHI		Data	SECTIUNI TRANSVERSALE DC8
Verificat	ing.Sorin PANA		APRILIE 2024	PISTA BICICLETE - TRASEU DUS - INTORS
				Planșa nr. T.04

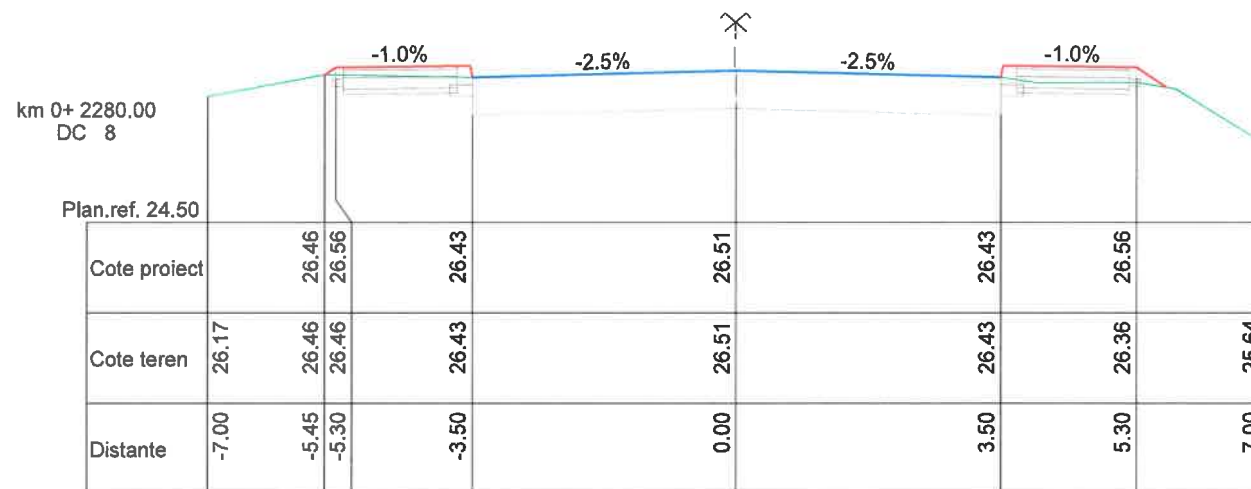
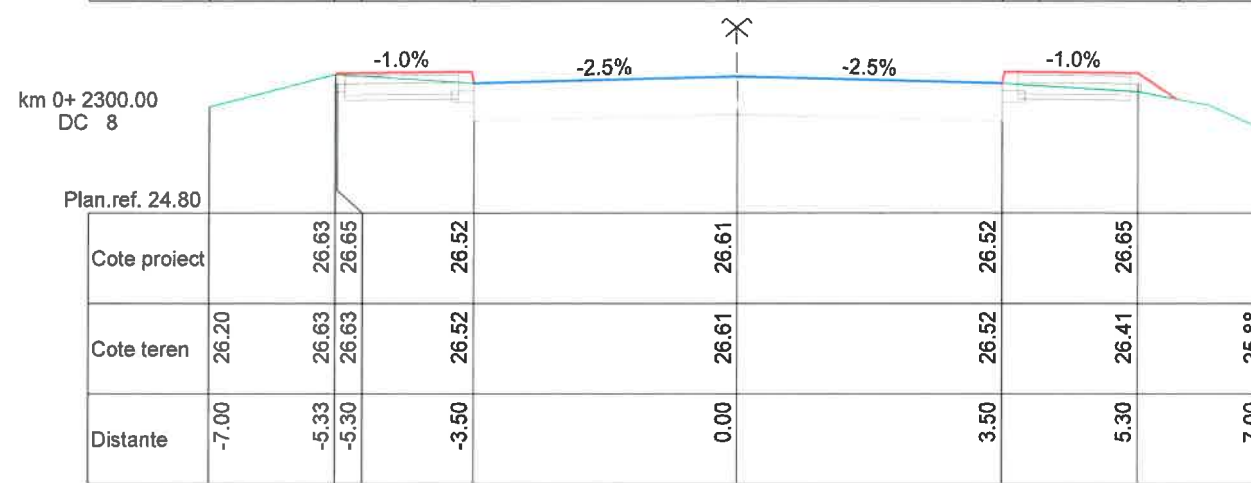
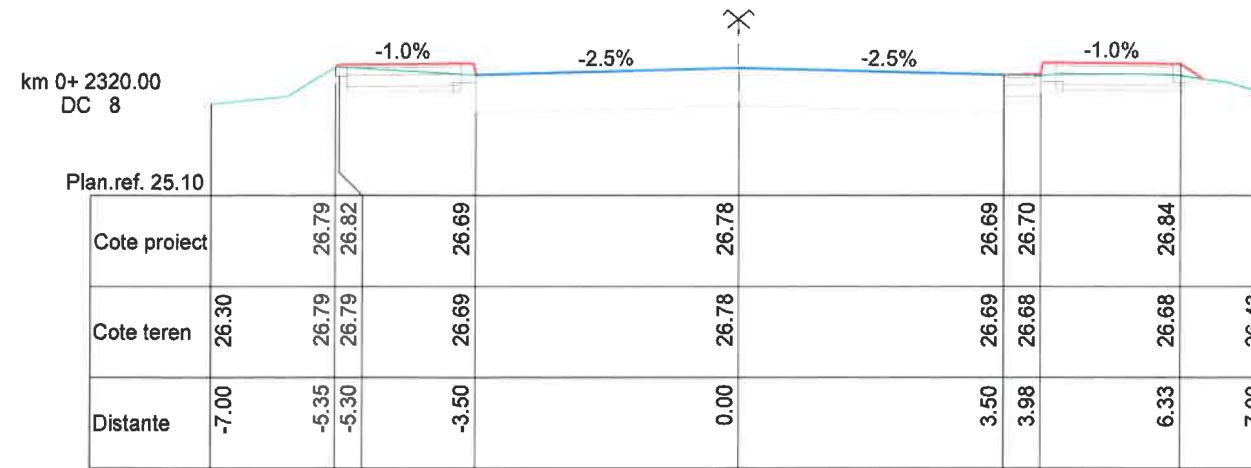
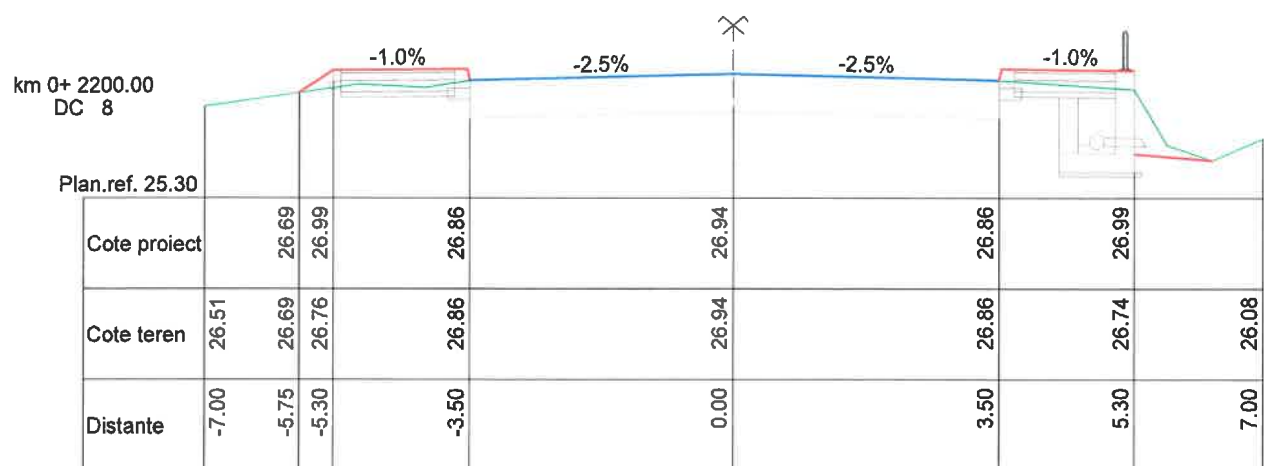
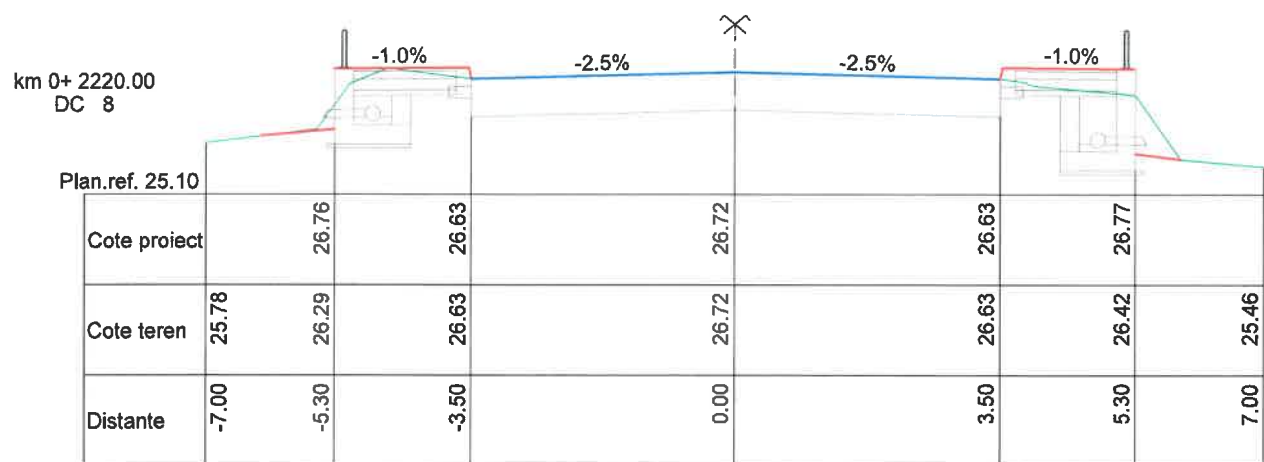
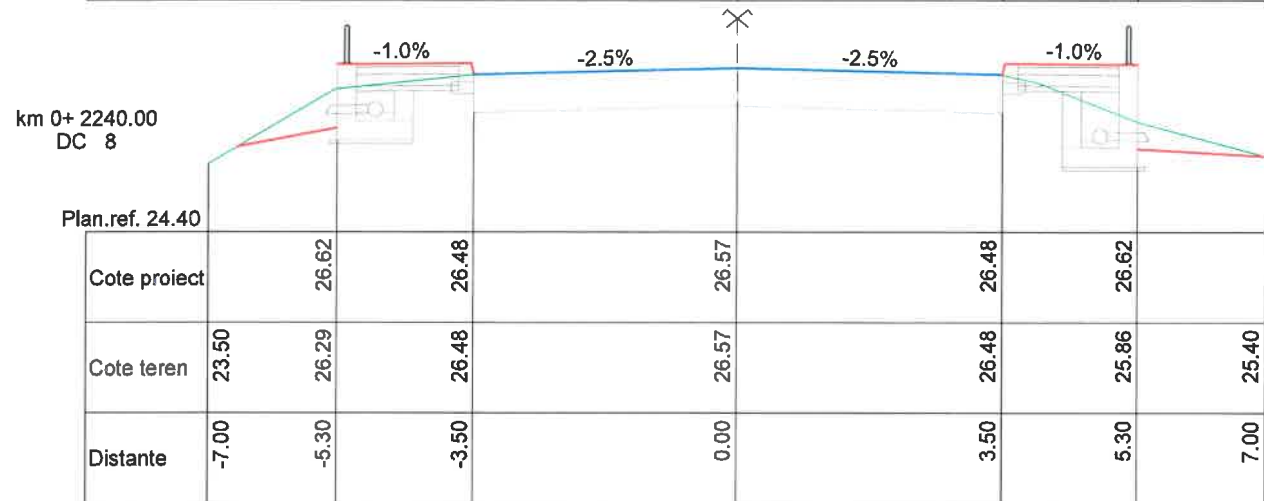
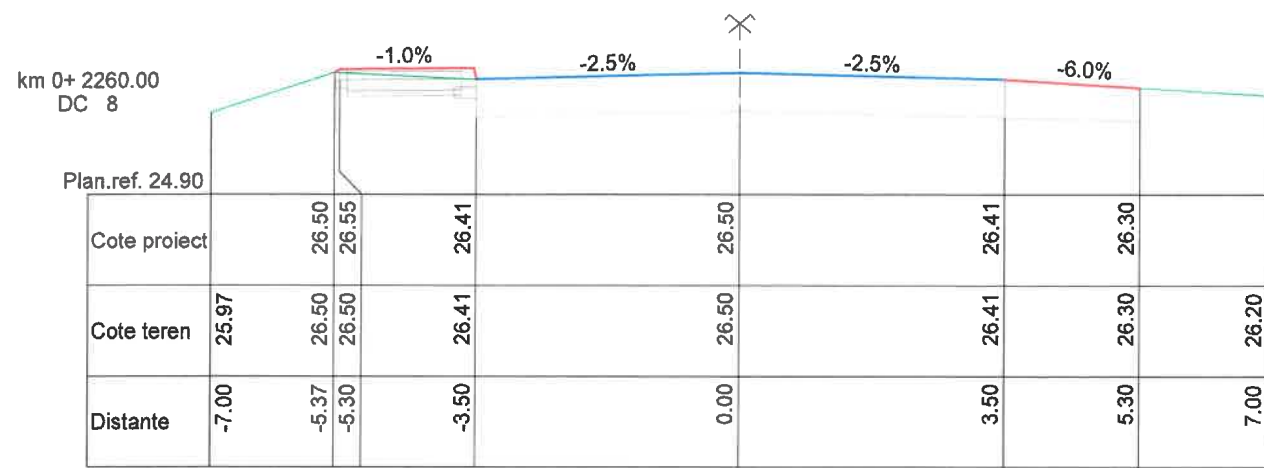

Verificator	Nume	Semnatura	Cerinta	Referat nr./data
Proiectant:	1 ENGINEERING		Beneficiar:	COMUNA LIMANU, JUDEȚUL CONSTANȚA
1ENGINEERING SRL • RO28725629 • J13/1567/2011 • CONSTANTA, B-DUL TOMIS, NR.143A				Proiect nr. 241/2024
Sef proiect	ing.Sorin PANA	<i>[Signature]</i>	Scara 1:100	Faza: P.T.+D.E.
Proiectat	ing.Andreea ANTOHI	<i>[Signature]</i>	Data APRILIE 2024	Planșa nr. T.05
Verificat	ing.Sorin PANA	<i>[Signature]</i>		
				ASIGURAREA INFRASTRUCTURII PENTRU TRANSPORT VERDE - PISTA DE BICICLETE IN COMUNA LIMANU, JUDEȚUL CONSTANTA
				SECTIUNI TRANSVERSALE DC8 PISTA BICICLETE - TRASEU DUS - INTORS



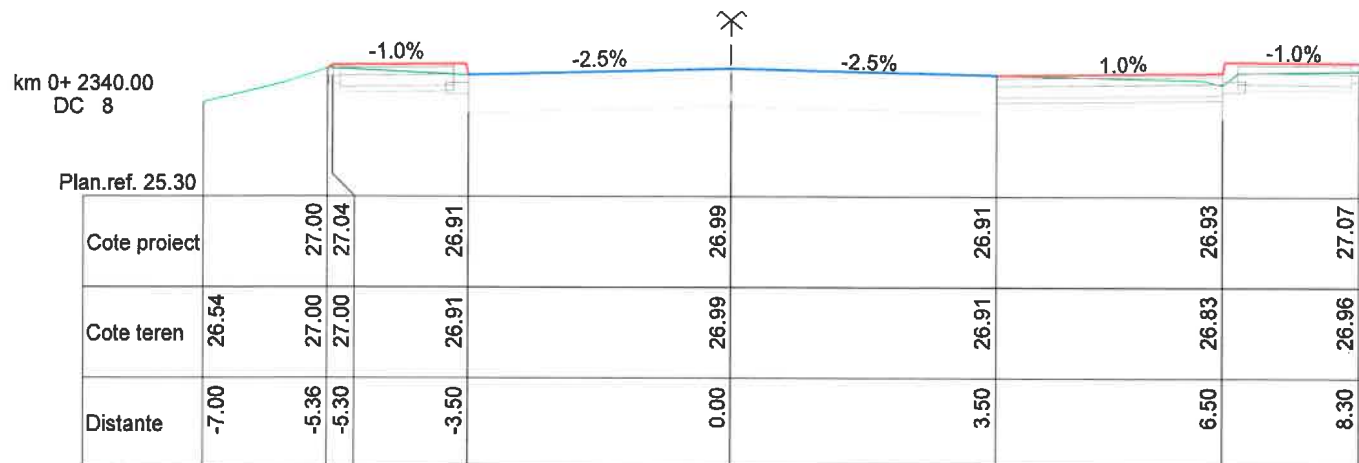
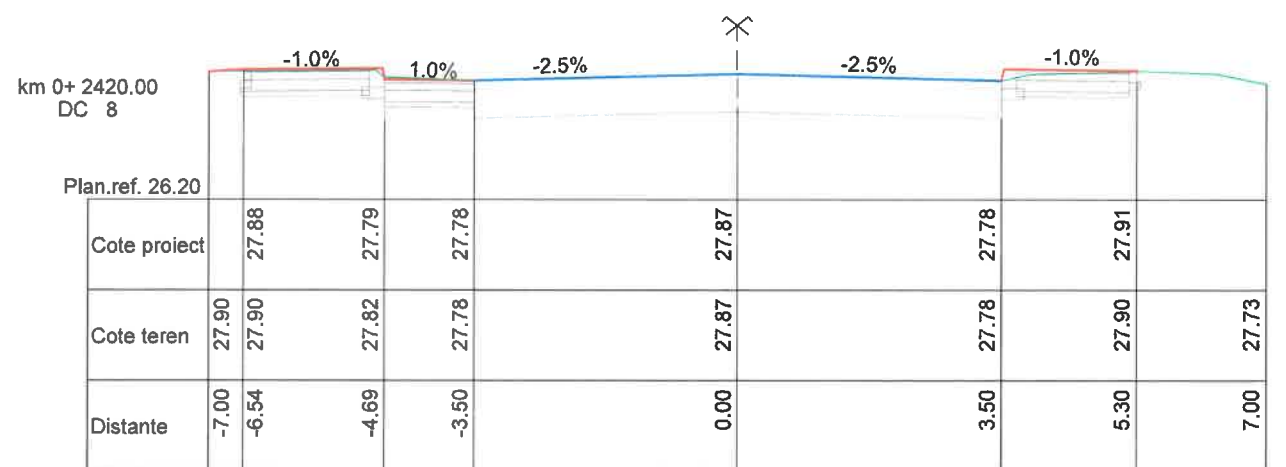
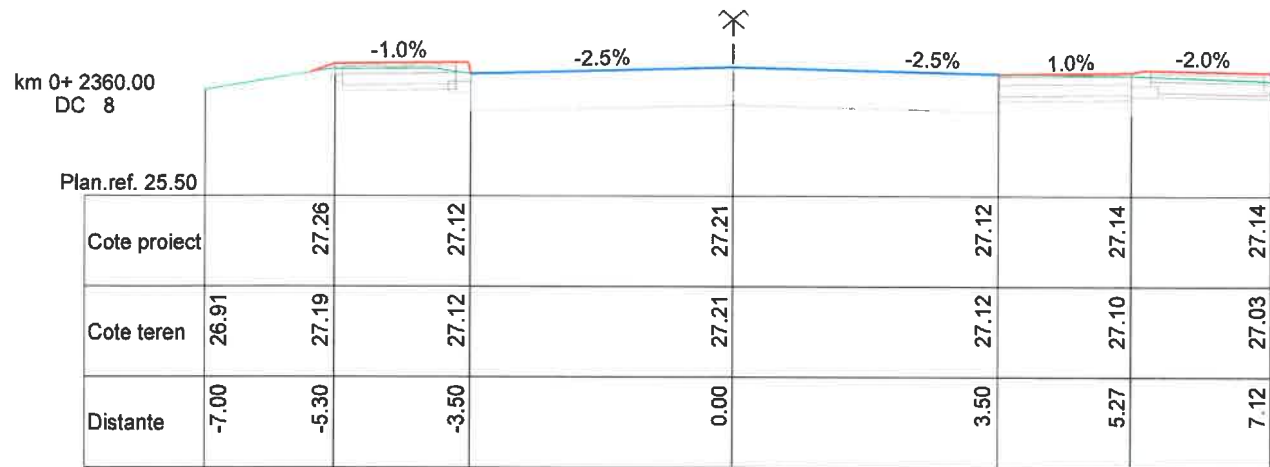
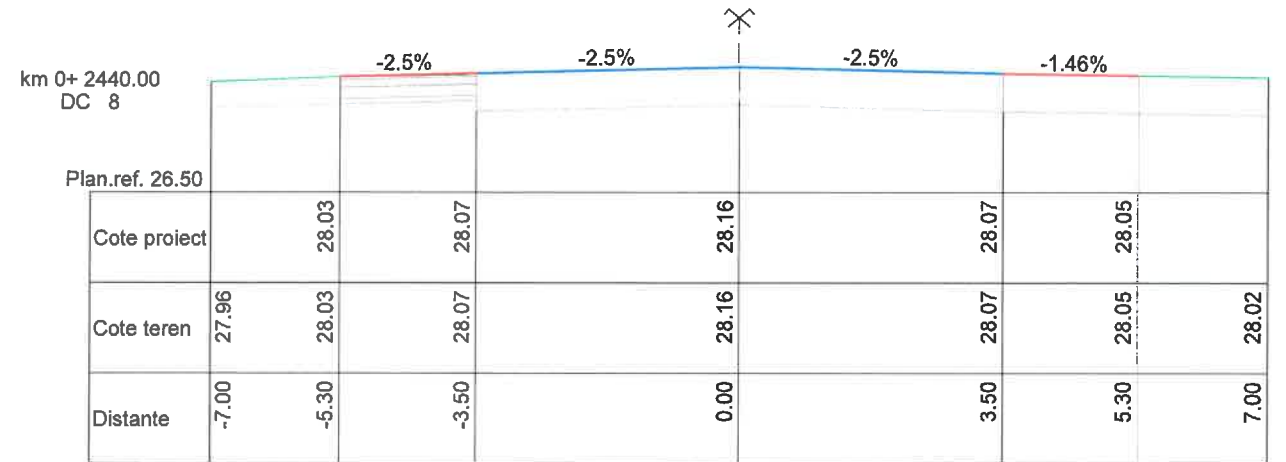
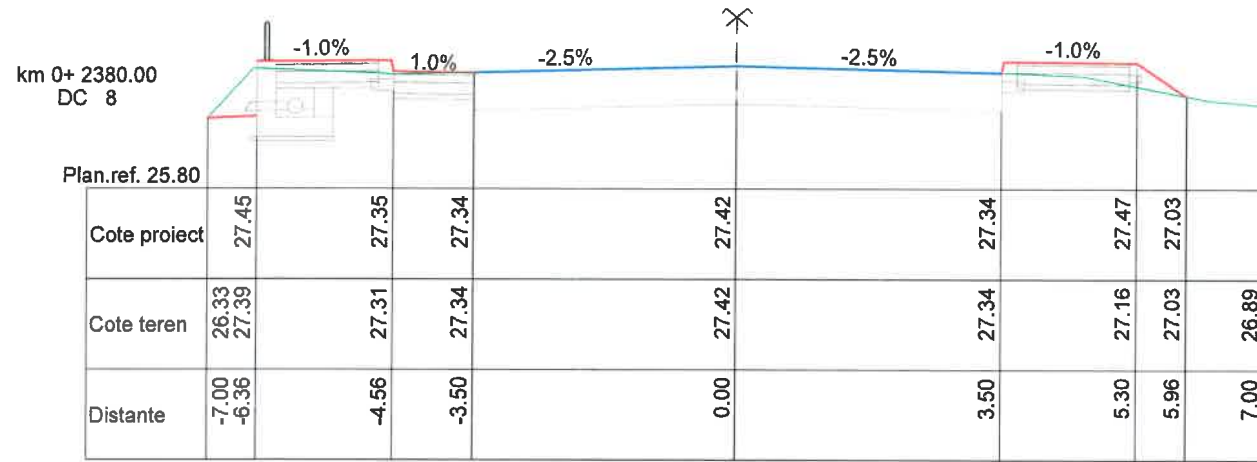
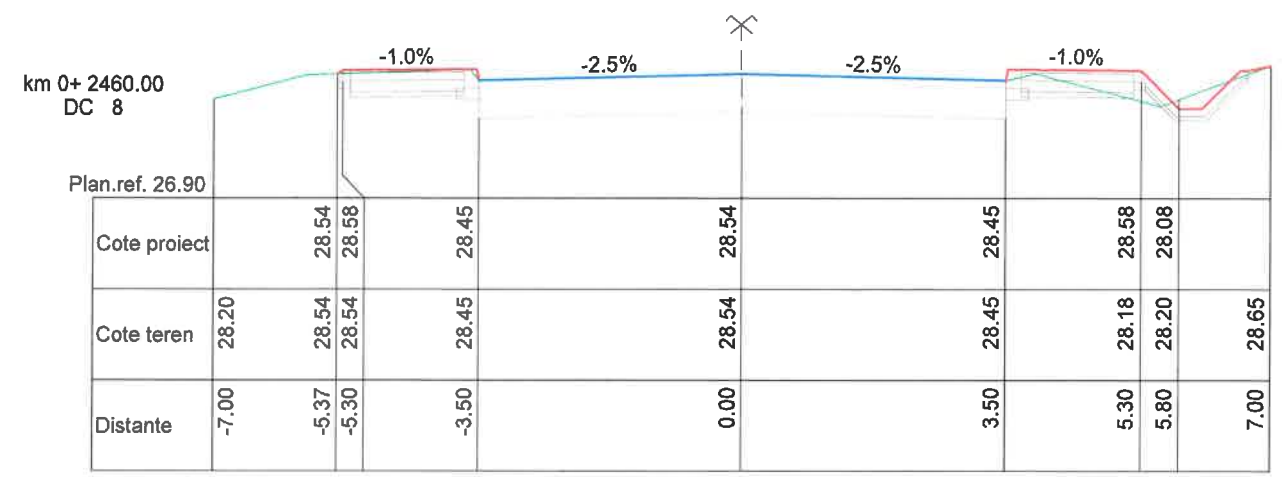
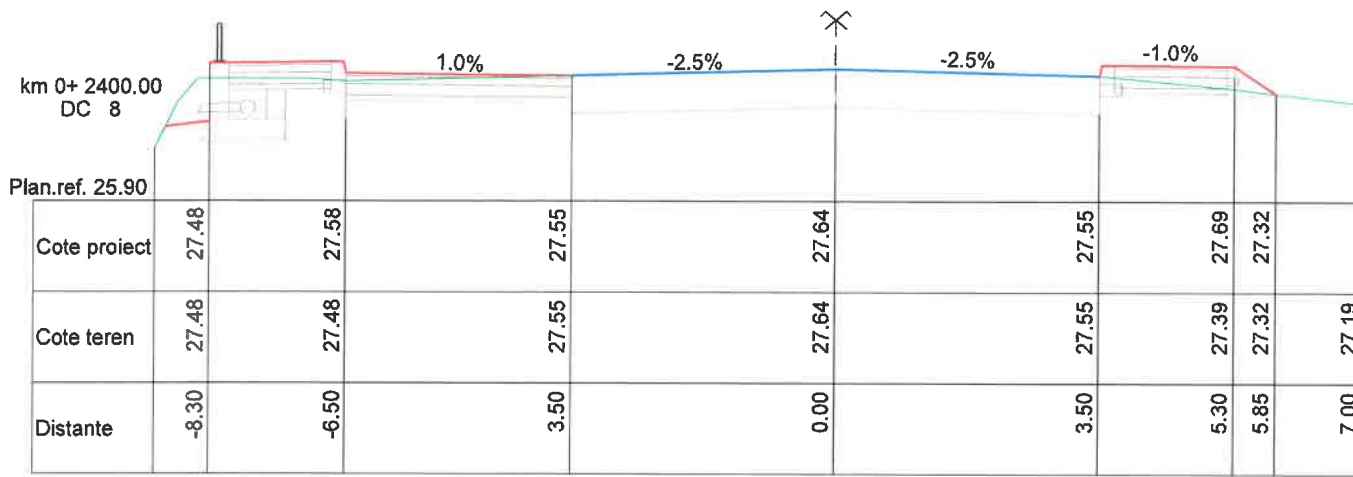

Verificator	Nume	Semnatura	Cerinta	Referat nr./data
Proiectant:	ENGINEERING			Beneficiar: COMUNA LIMANU, JUDEȚUL CONSTANȚA
<small>ENGINEERING SRL • RO28725629 • J13/1567/2011 • CONSTANTA, B-DUL TOMIS, NR.143A</small>				Proiect nr. 241/2024
Sef proiect	ing.Sorin PANA		Scara 1:100	Faza: P.T.+D.E.
Proiectat	ing.Andreea ANTOHI		Data APRILIE 2024	Planșa nr. T.06
Verificat	ing.Sorin PANA			

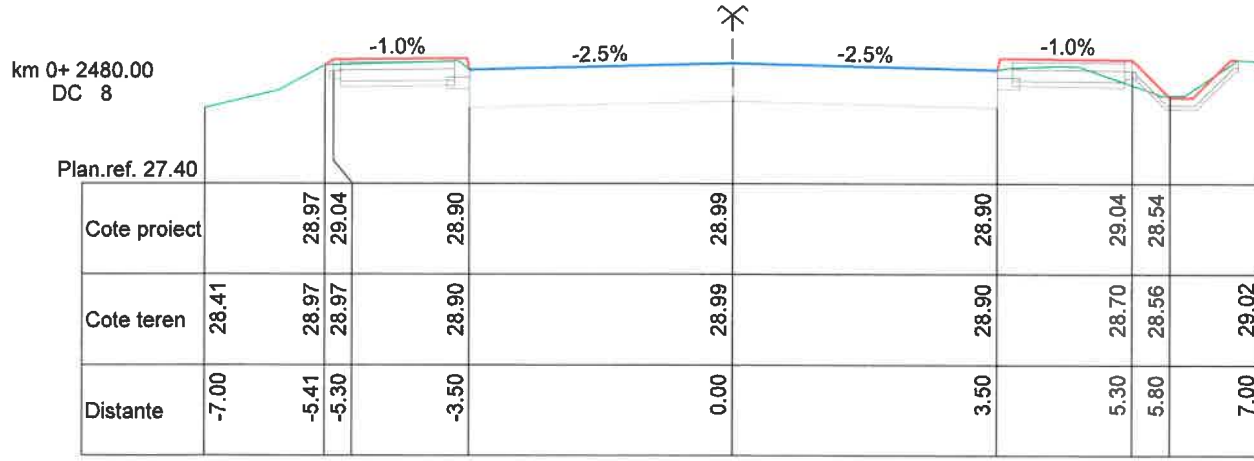
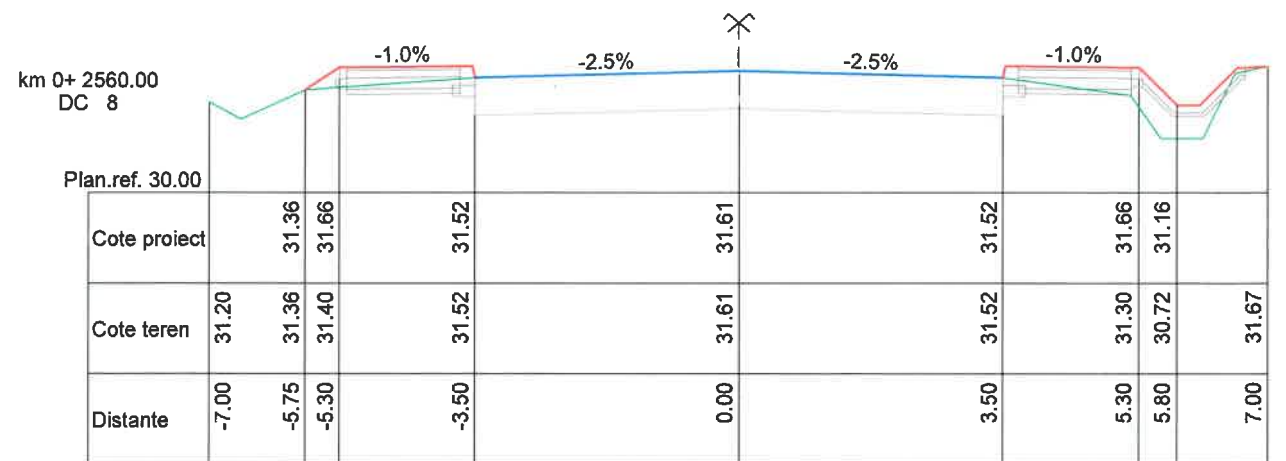
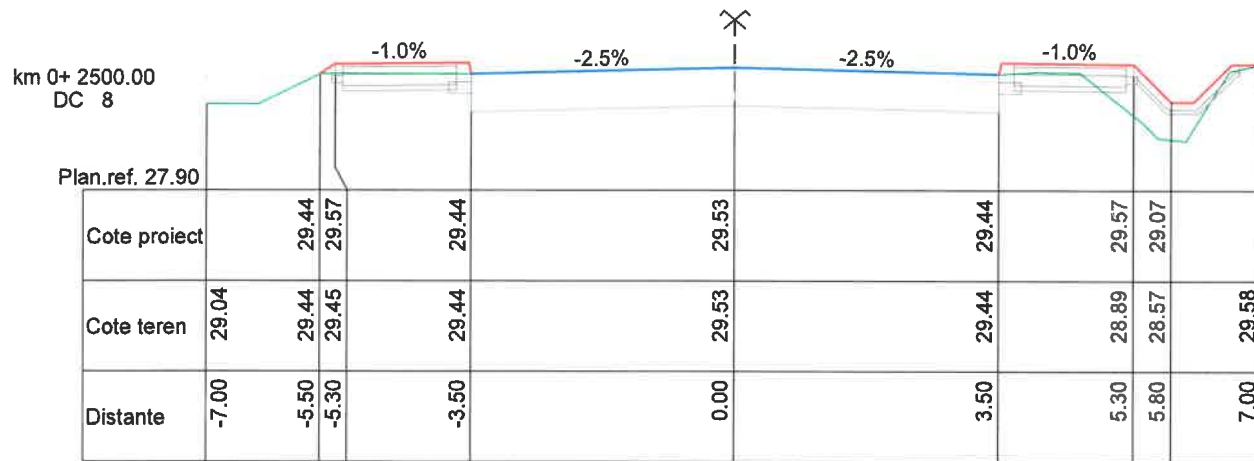
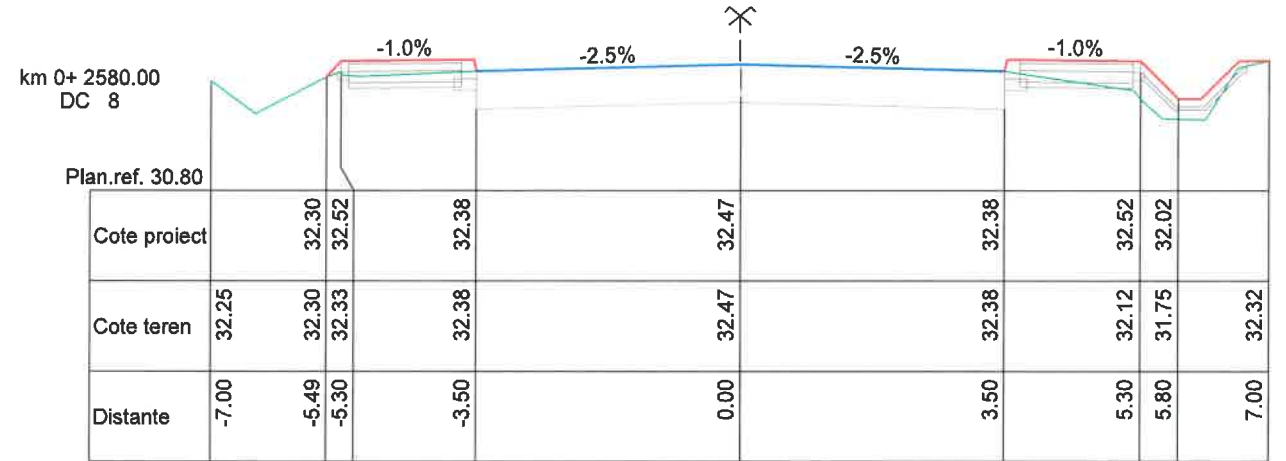
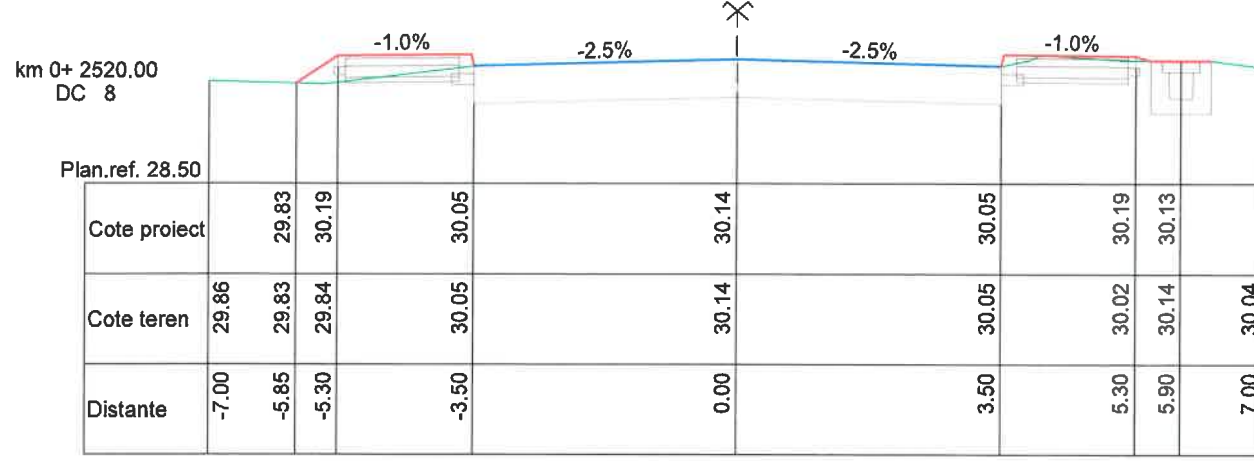
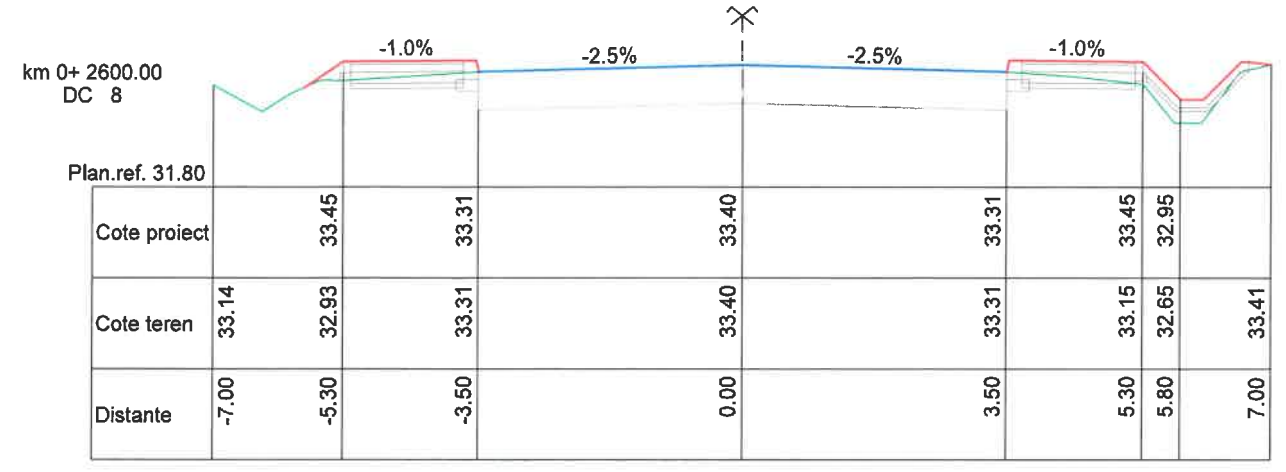
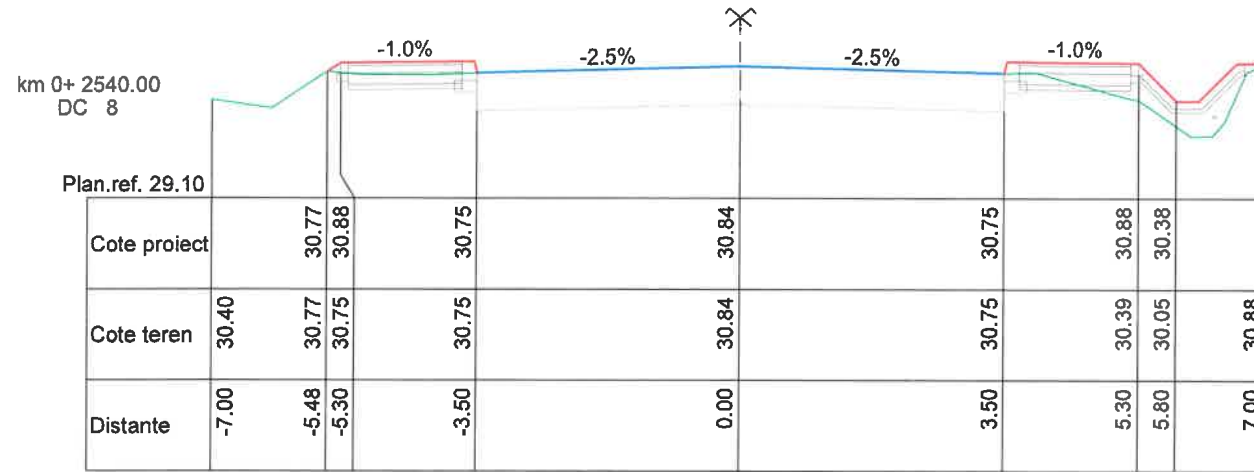

Verificator	Nume	Semnatura	Cerinta	Referat nr./data
Proiectant:	ENGINEERING			Beneficiar: COMUNA LIMANU, JUDEȚUL CONSTANȚA
1ENGINEERING SRL • RO28725629 • J13/1567/2011 • CONSTANTA, B-DUL TOMIS, NR.143A				Proiect nr. 241/2024
Sef proiect	ing.Sorin PANA		Scara 1:100	Faza: P.T.+D.E.
Proiectat	ing.Andreea ANTOHI		Data APRILIE 2024	Plansa nr. T.07
Verificat	ing.Sorin PANA			

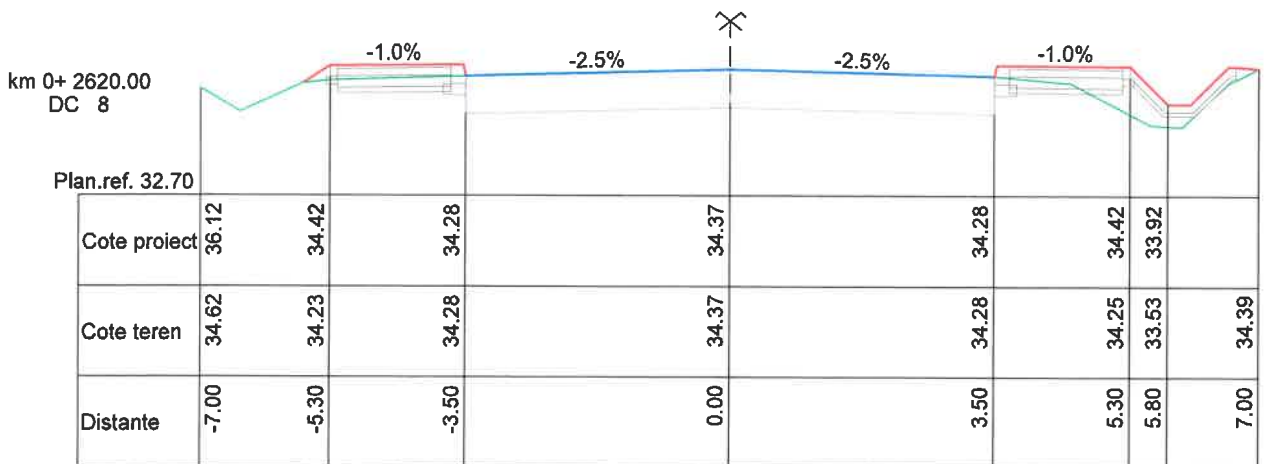
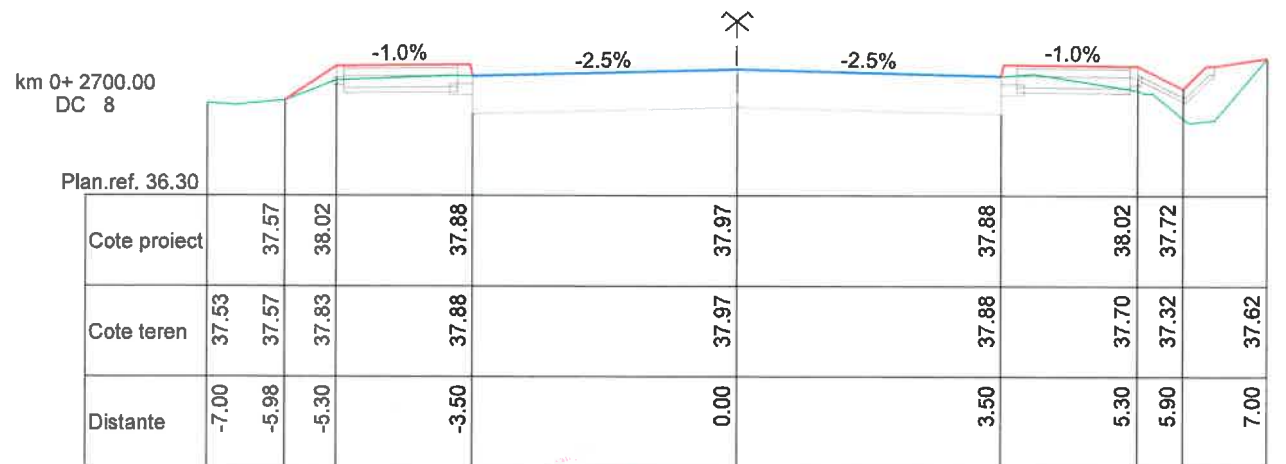
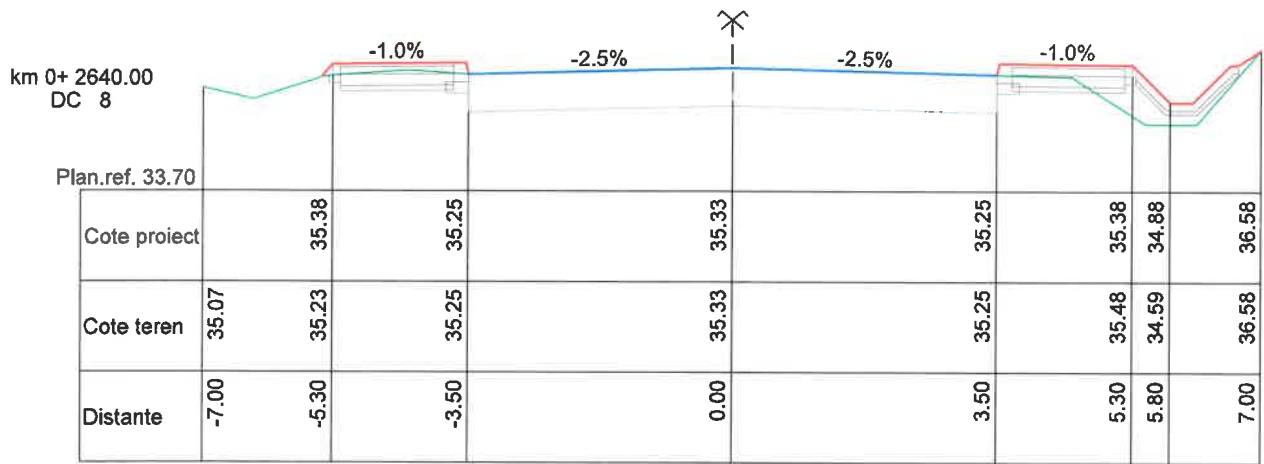
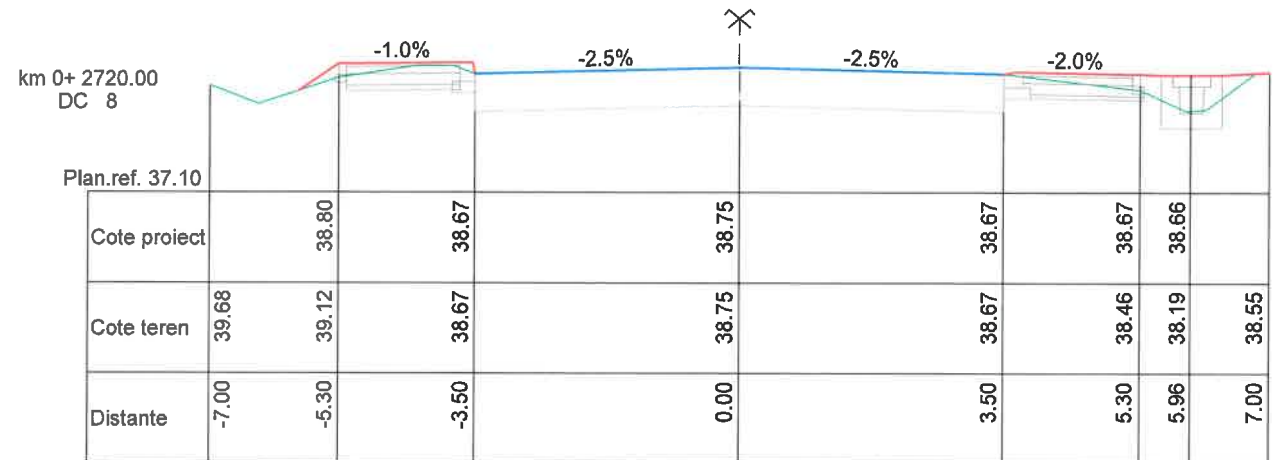
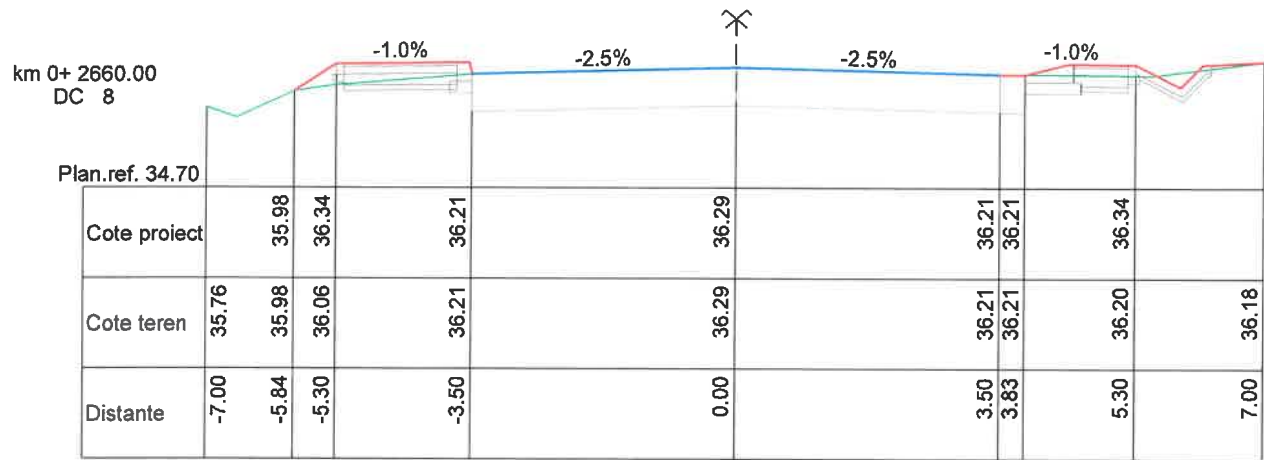
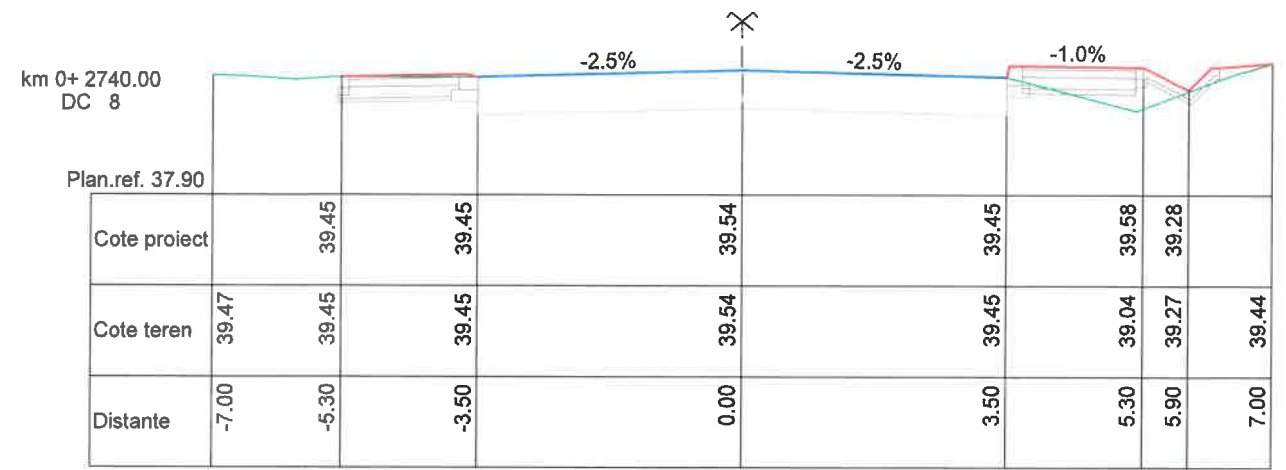
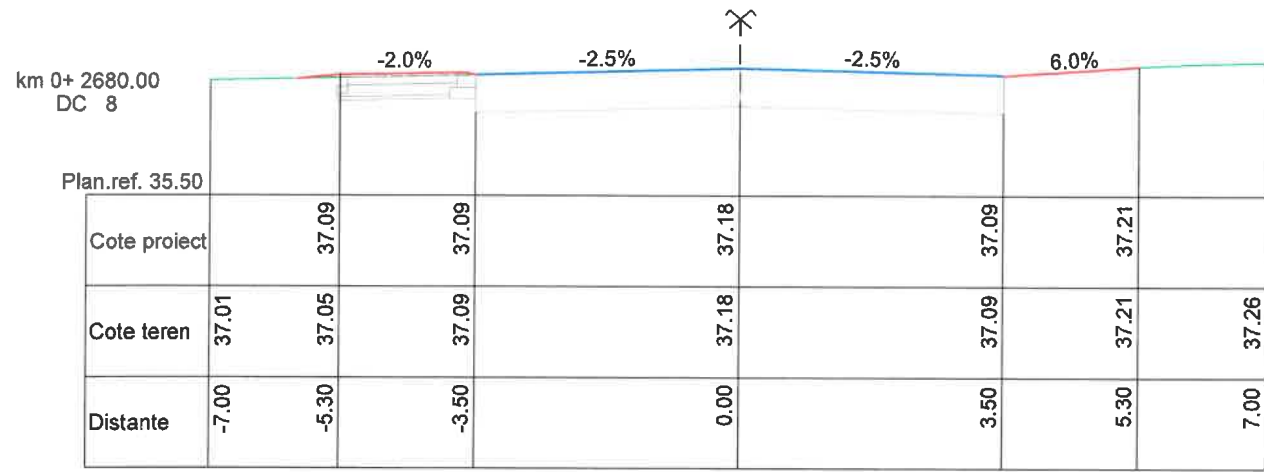

Verificator	Nume	Semnatura	Cerinta	Referat nr./data
Proiectant:	ENGINEERING		Beneficiar:	COMUNA LIMANU, JUDEȚUL CONSTANȚA
1ENGINEERING SRL • RO28725629 • J13/1567/2011 • CONSTANTA, B-DUL TOMIS, NR.143A			Scara	ASIGURAREA INFRASTRUCTURII PENTRU TRANSPORT VERDE - PISTA DE BICICLETE IN COMUNA LIMANU, JUDEȚUL CONSTANTA
Sef proiect	ing.Sorin PANA	<i>[Signature]</i>	1:100	Faza: P.T.+D.E.
Proiectat	ing.Andreea ANTOHI	<i>[Signature]</i>	Data	SECTIUNI TRANSVERSALE DC8
Verificat	ing.Sorin PANA	<i>[Signature]</i>	APRILIE 2024	PISTA BICICLETE - TRASEU DUS - INTORS
				Planșa nr. T.08

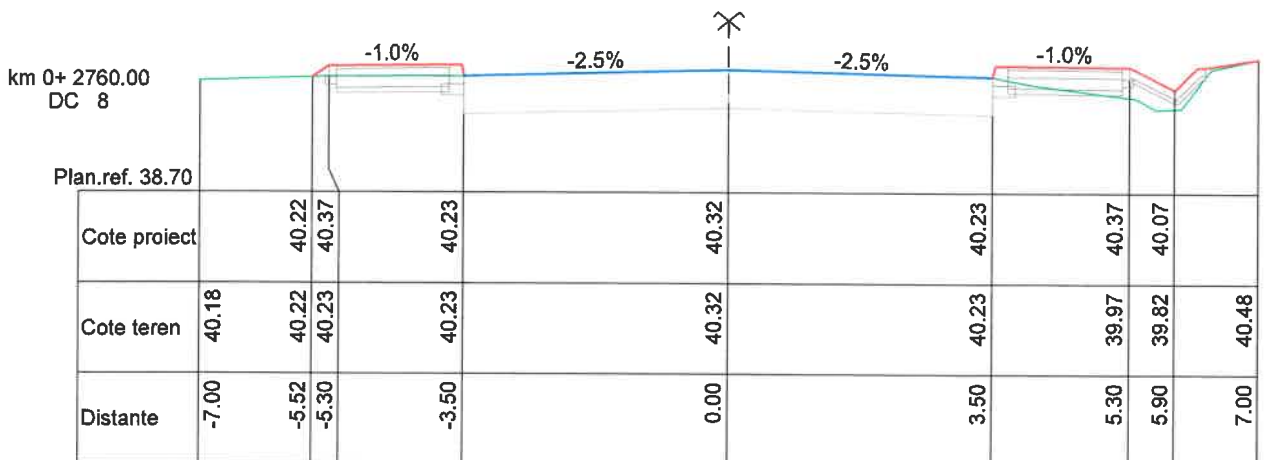
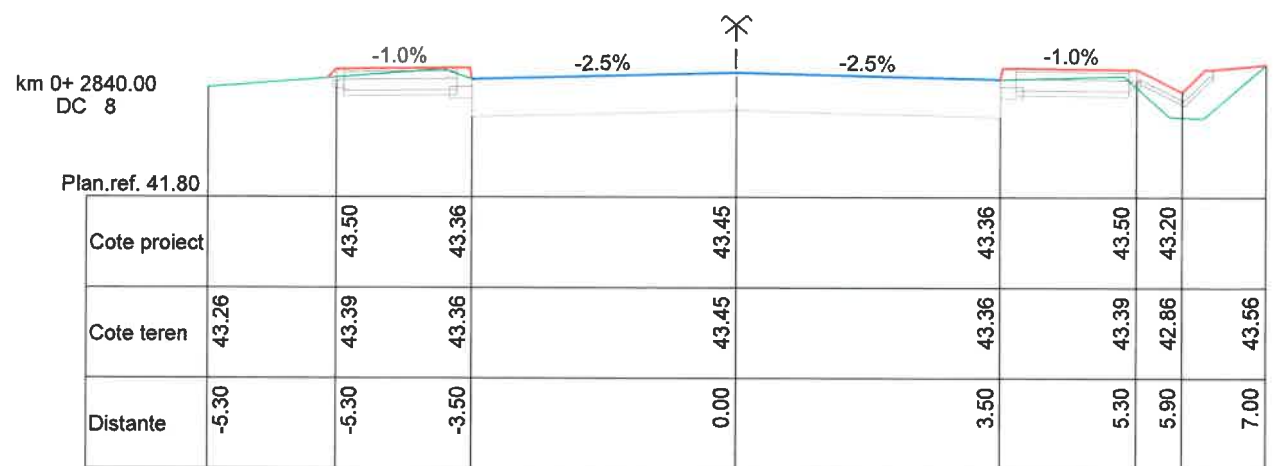
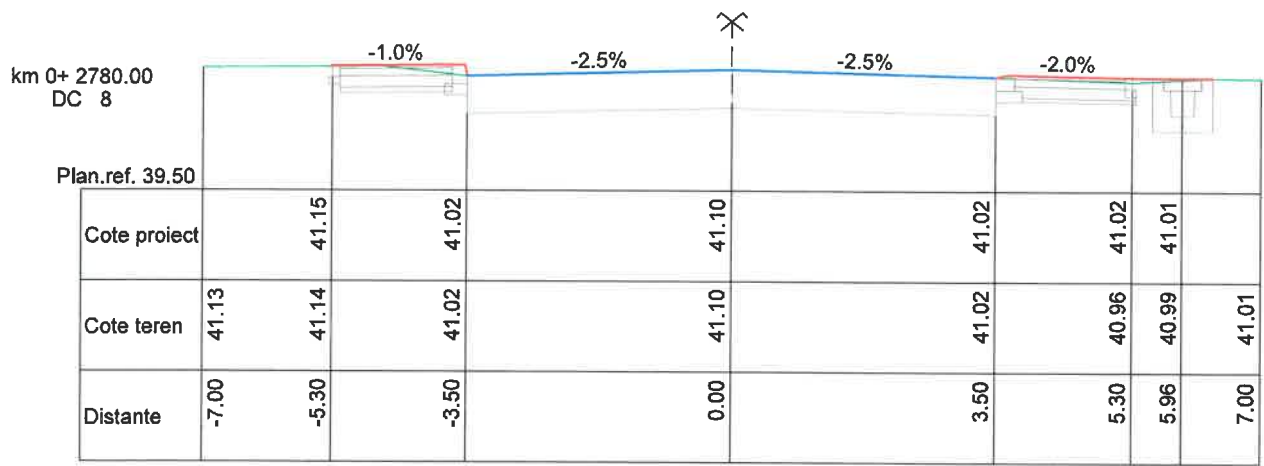
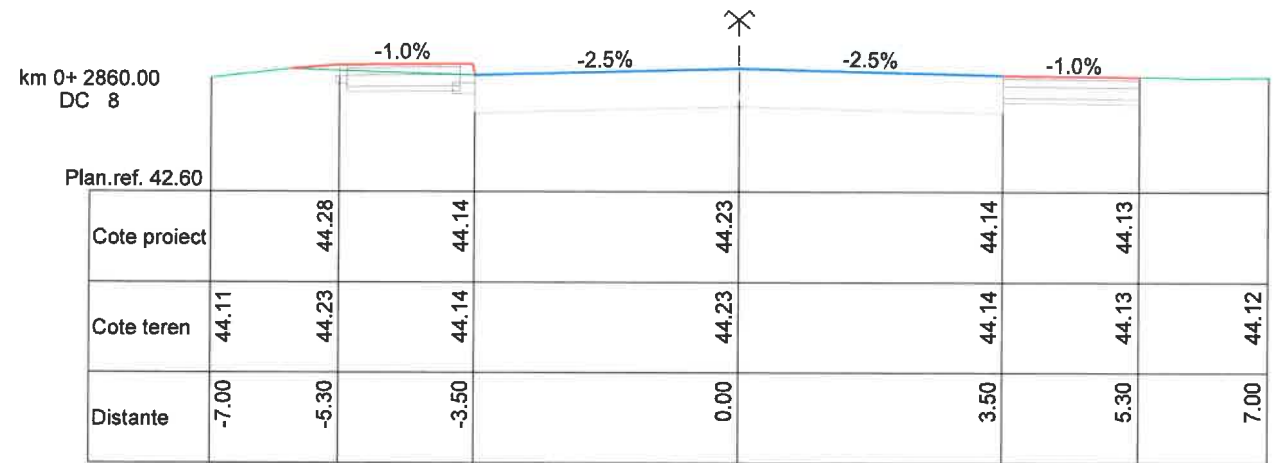
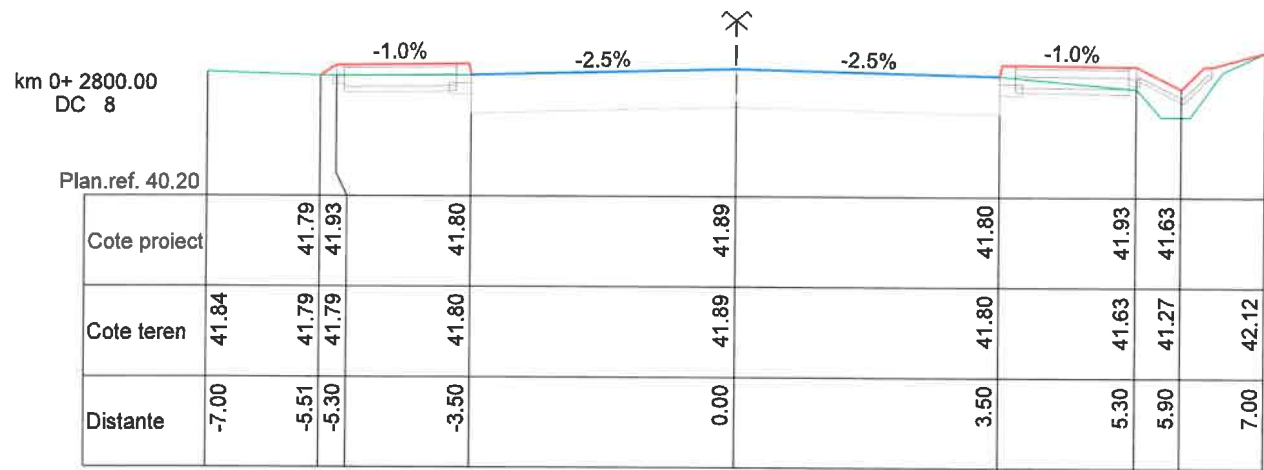
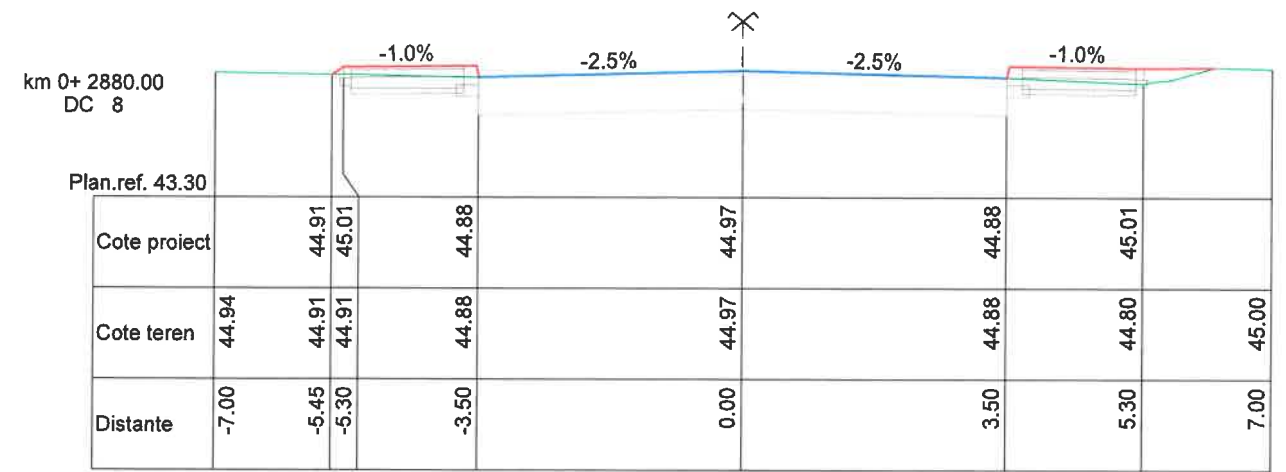
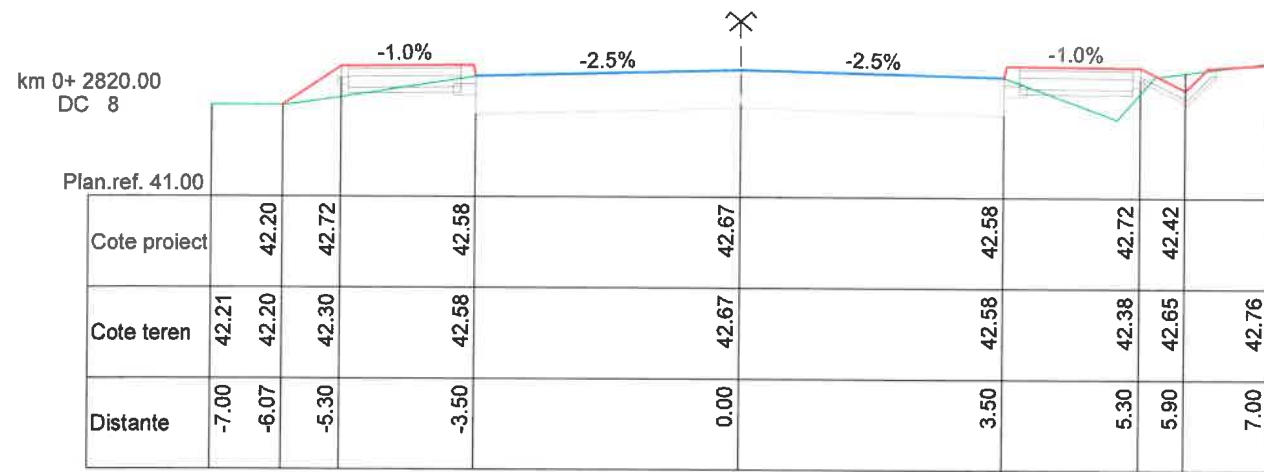

Verificator	Nume	Semnatura	Cerinta	Referat nr./data
Proiectant:	ENGINEERING			Beneficiar: COMUNA LIMANU, JUDEȚUL CONSTANȚA
<small>ENGINEERING SRL • RO28725629 • J13/1567/2011 • CONSTANTA, B-DUL TOMIS, NR.143A</small>				Proiect nr. 241/2024
Sef proiect	ing.Sorin PANA		Scara 1:100	Faza: P.T.+D.E.
Proiectat	ing.Andreea ANTOHI		Data APRILIE 2024	Plansa nr. T.09
Verificat	ing.Sorin PANA			

ASIGURAREA INFRASTRUCTURII PENTRU TRANSPORT VERDE - PISTA DE BICICLETE IN COMUNA LIMANU, JUDEȚUL CONSTANTA
SECTIUNI TRANSVERSALE DC8 PISTA BICICLETE - TRASEU DUS - INTORS

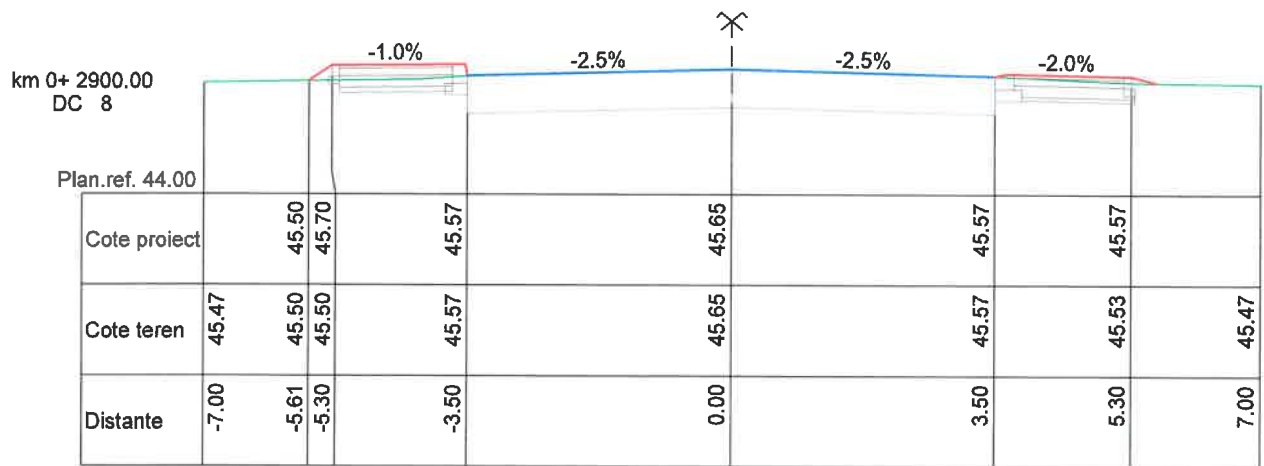
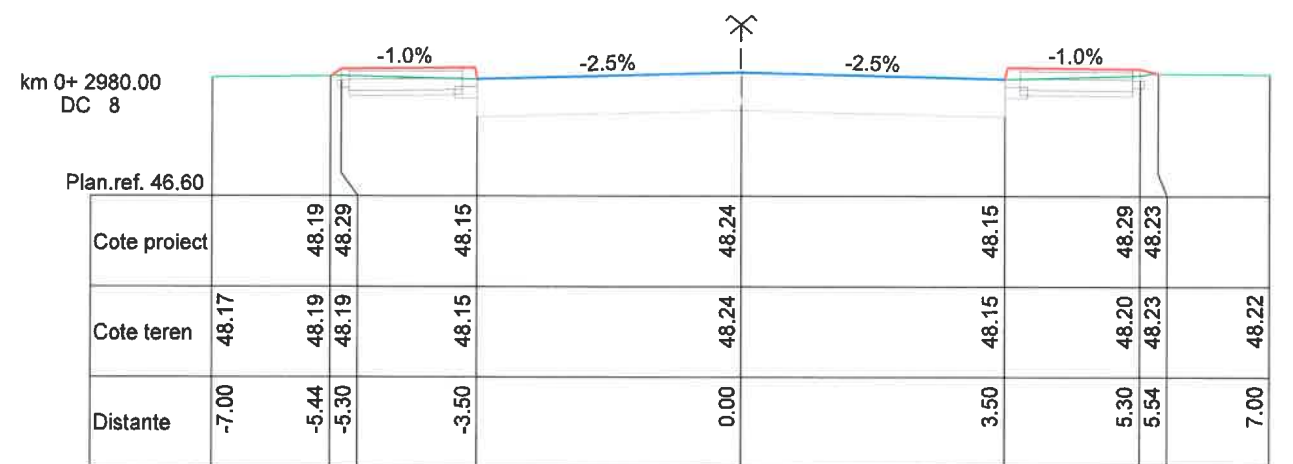
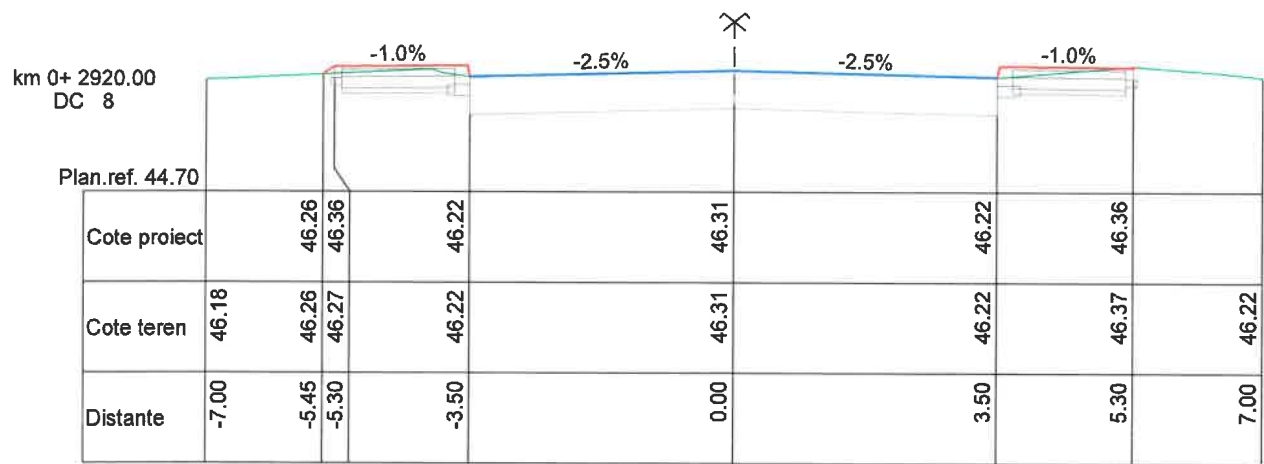
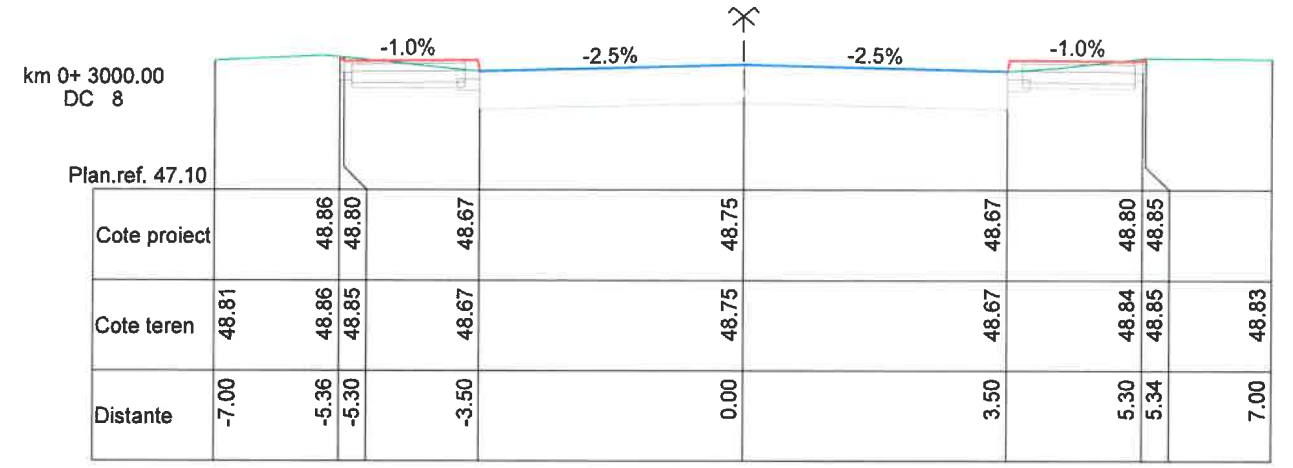
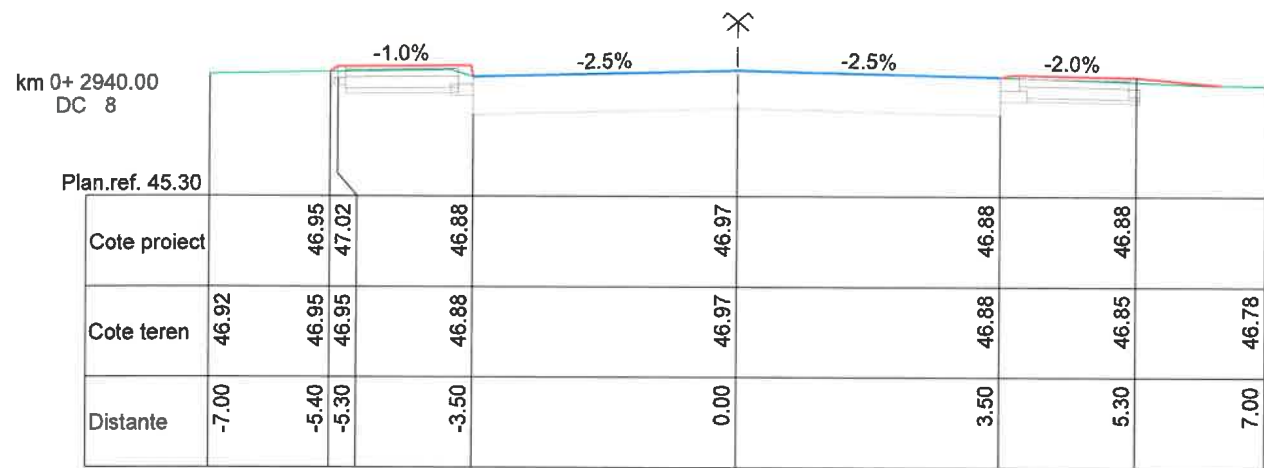
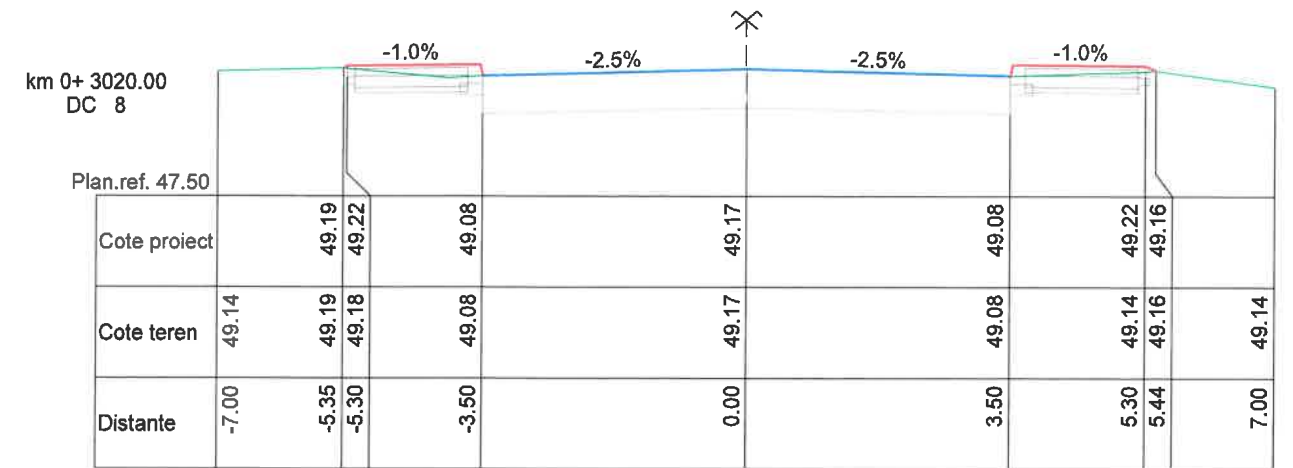
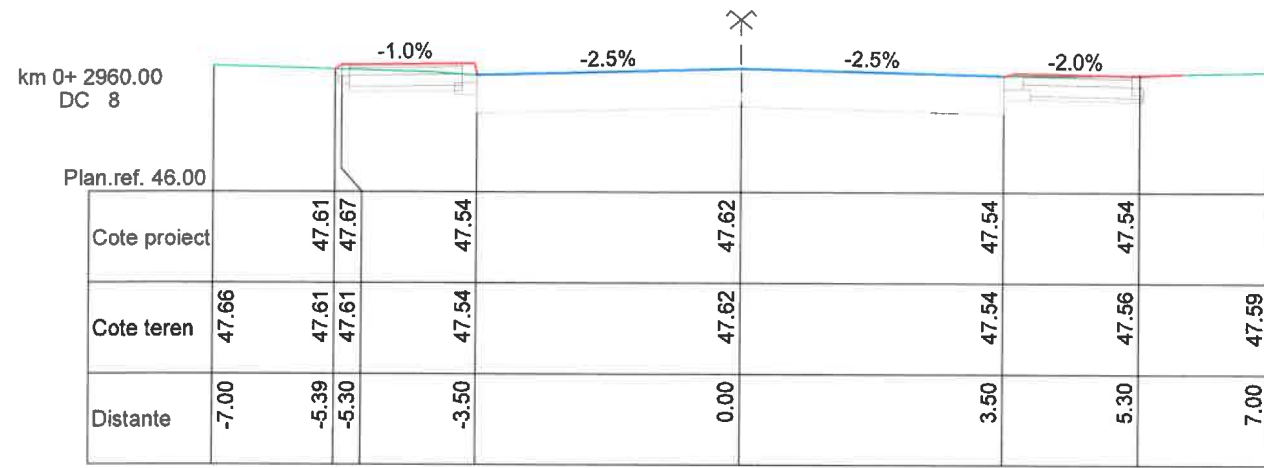

Verificator	Nume	Semnatura	Cerinta	Referat nr./data
Proiectant:	1ENGINEERING			Beneficiar: COMUNA LIMANU, JUDEȚUL CONSTANȚA
1ENGINEERING SRL • RO28725629 • J13/1587/2011 • CONSTANTA, B-DUL TOMIS, NR.143A				Proiect nr. 241/2024
Sef proiect	ing.Sorin PANA		Scara 1:100	Faza: P.T.+D.E.
Proiectat	ing.Andreea ANTOHI		Data APRILIE 2024	Plansa nr. T.10
Verificat	ing.Sorin PANA			

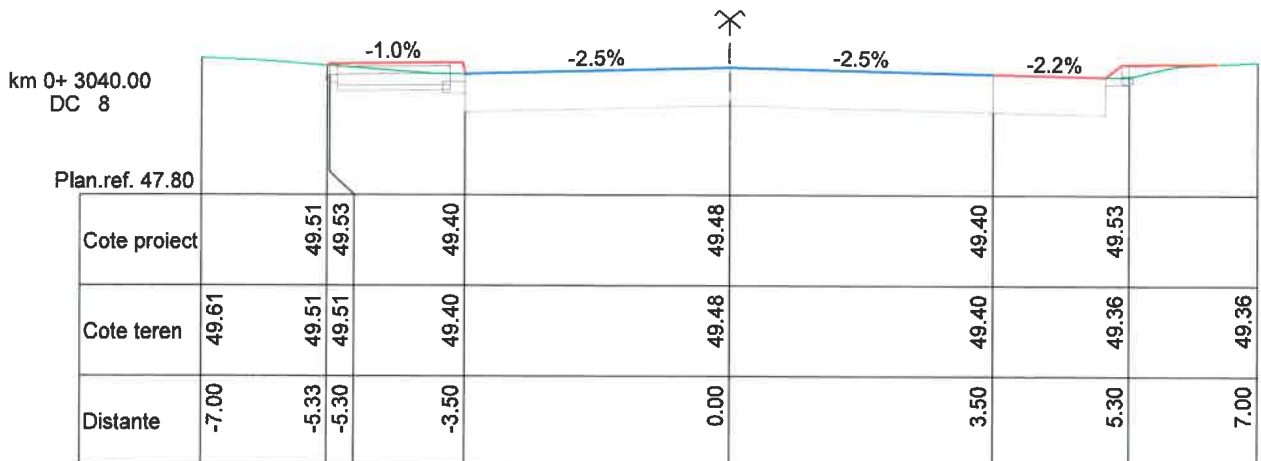
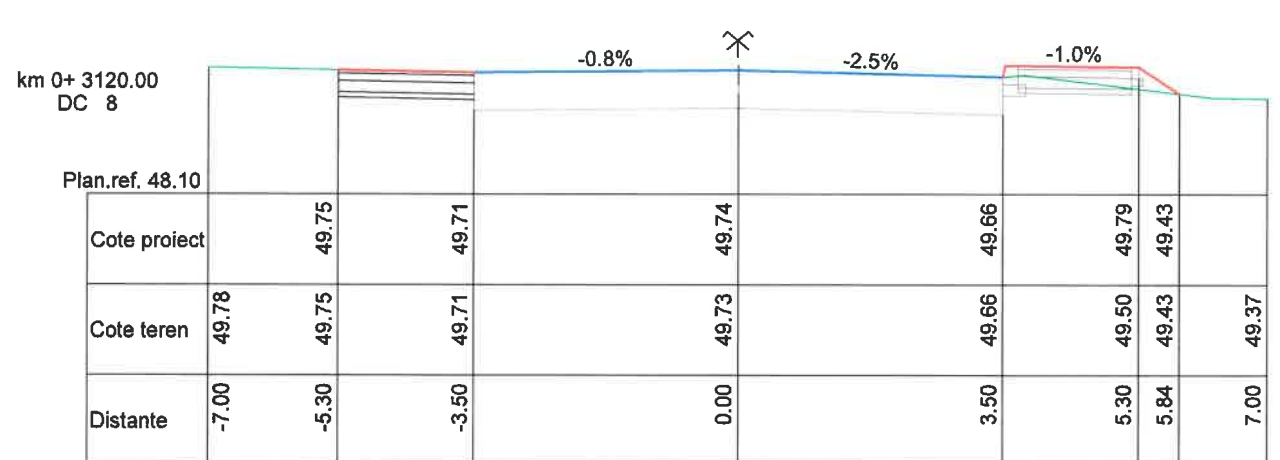
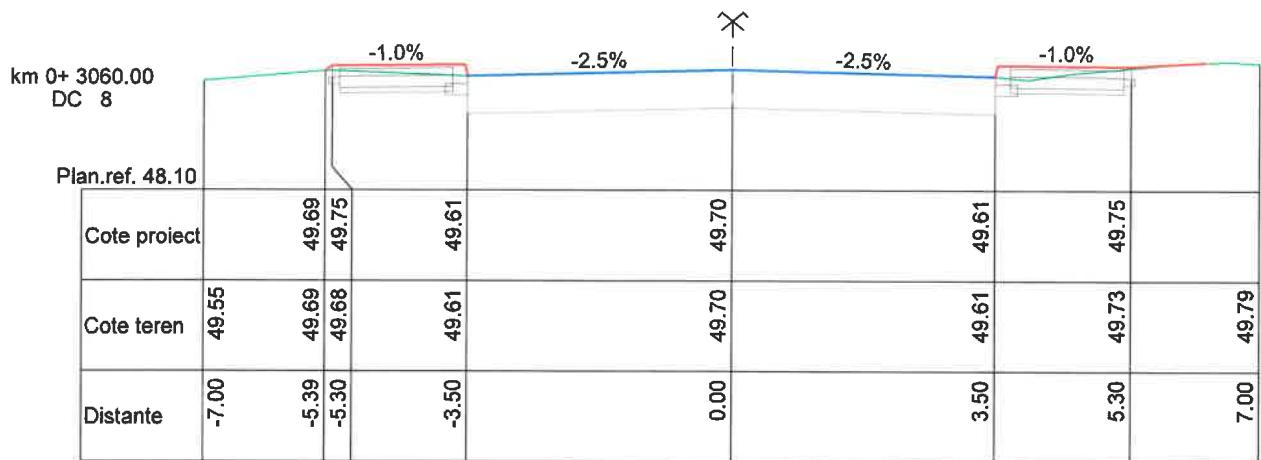
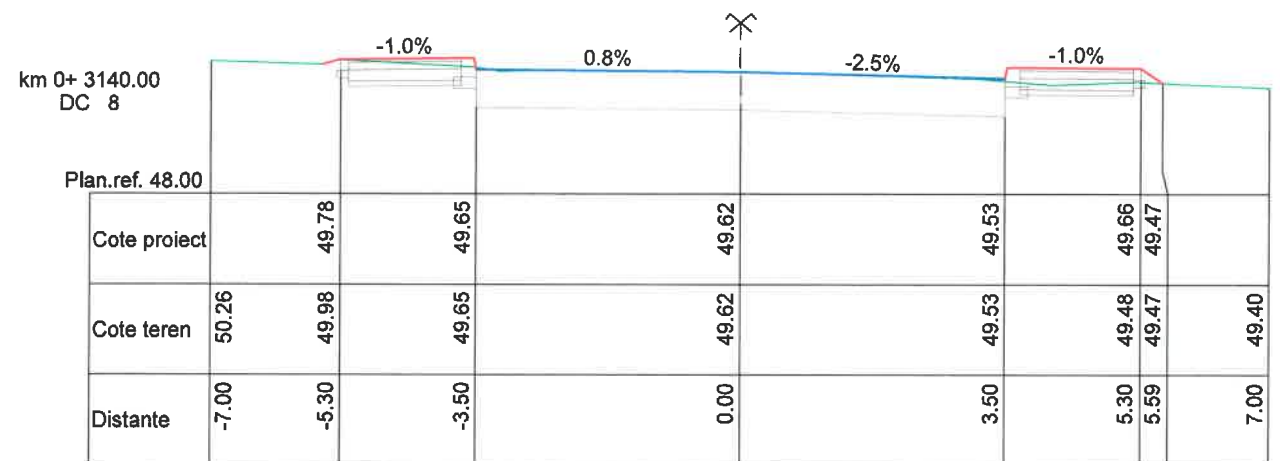
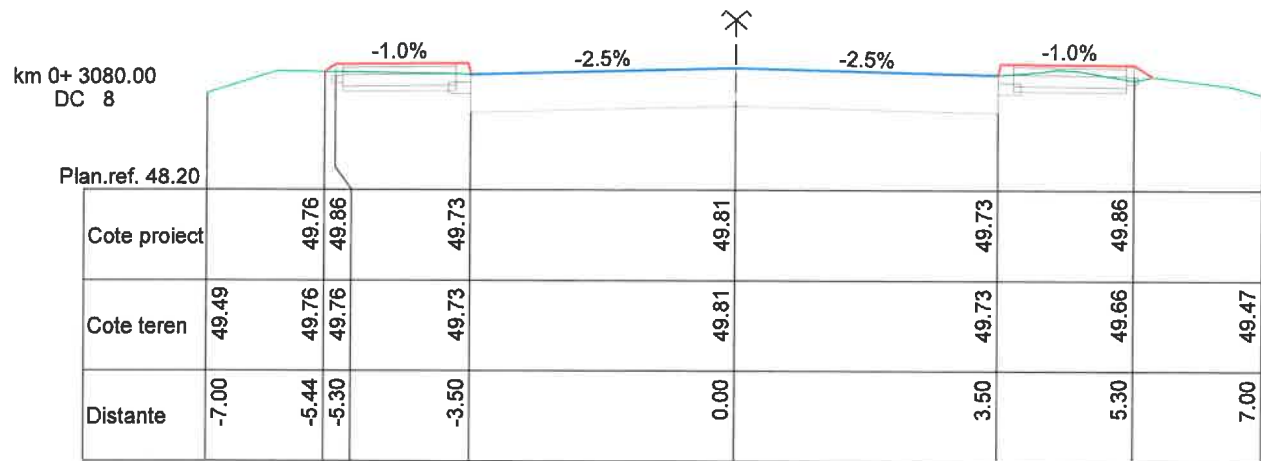
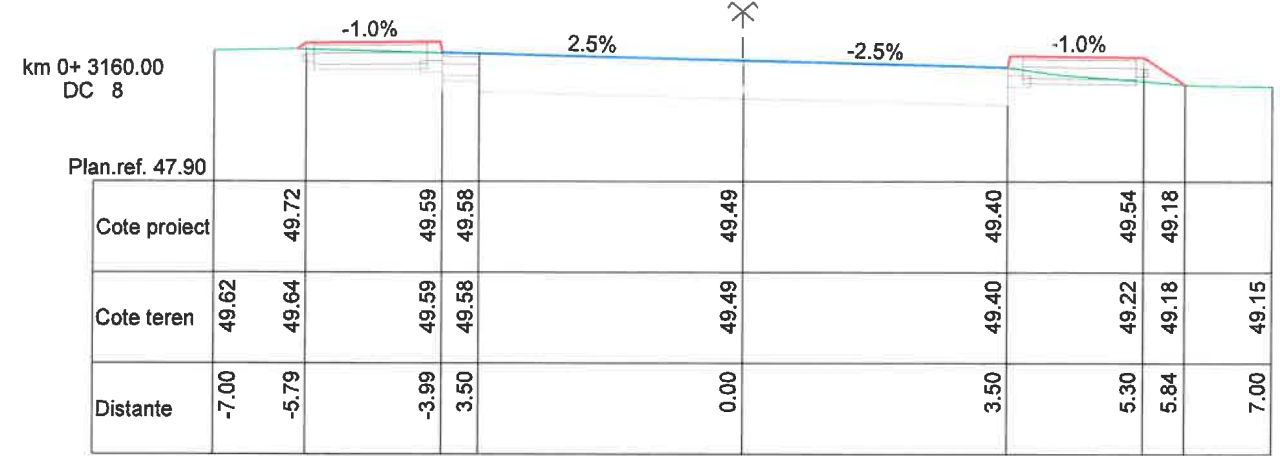
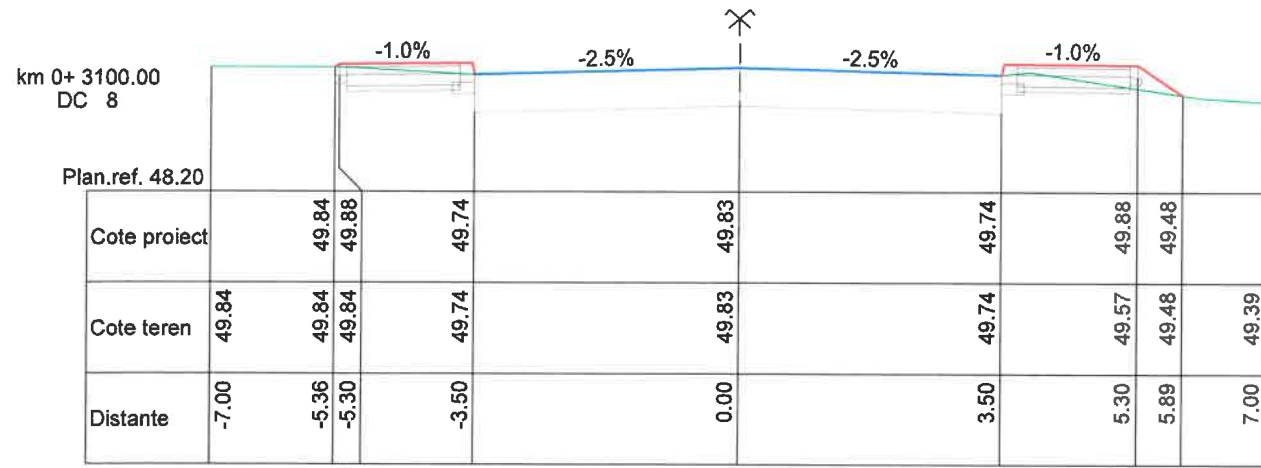

Verificator	Nume	Semnatura	Cerinta	Referat nr./data
Proiectant:	ENGINEERING		Beneficiar:	COMUNA LIMANU, JUDEȚUL CONSTANȚA
1ENGINEERING SRL • RO28725629 • J13/1567/2011 • CONSTANTA, B-OUA TOMIS, NR.143A			Scara	ASIGURAREA INFRASTRUCTURII PENTRU TRANSPORT VERDE - PISTA DE BICICLETE IN COMUNA LIMANU, JUDEȚUL CONSTANTA
Sef proiect	ing.Sorin PANA		1:100	Faza: P.T.+D.E.
Proiectat	ing.Andreea ANTOHI		Data	SECTIUNI TRANSVERSALE DC8
Verificat	ing.Sorin PANA		APRILIE 2024	PISTA BICICLETE - TRASEU DUS - INTORS
				Planșa nr. T.11

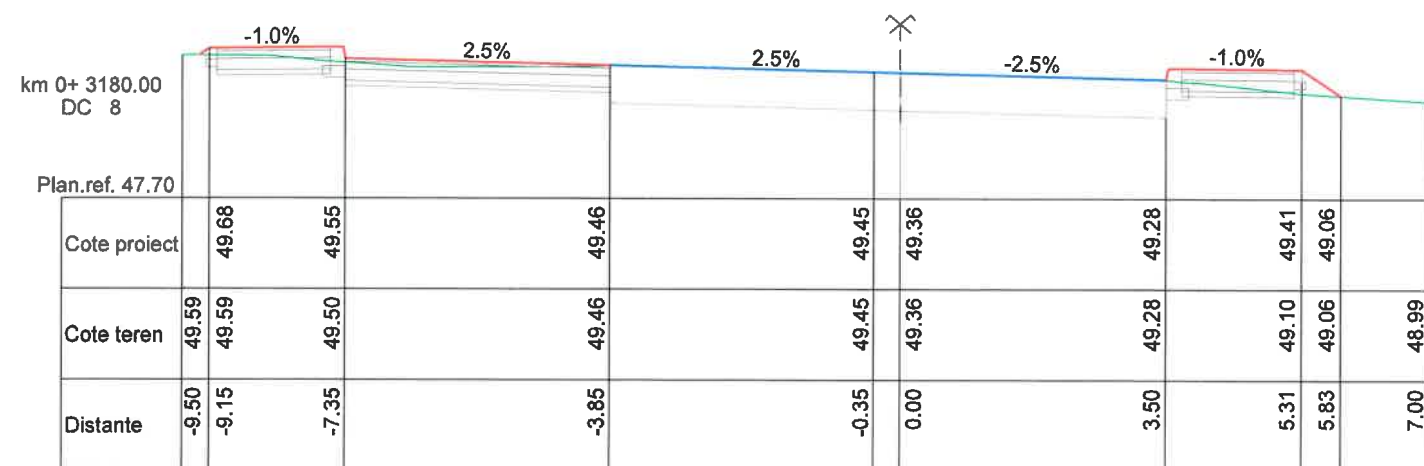
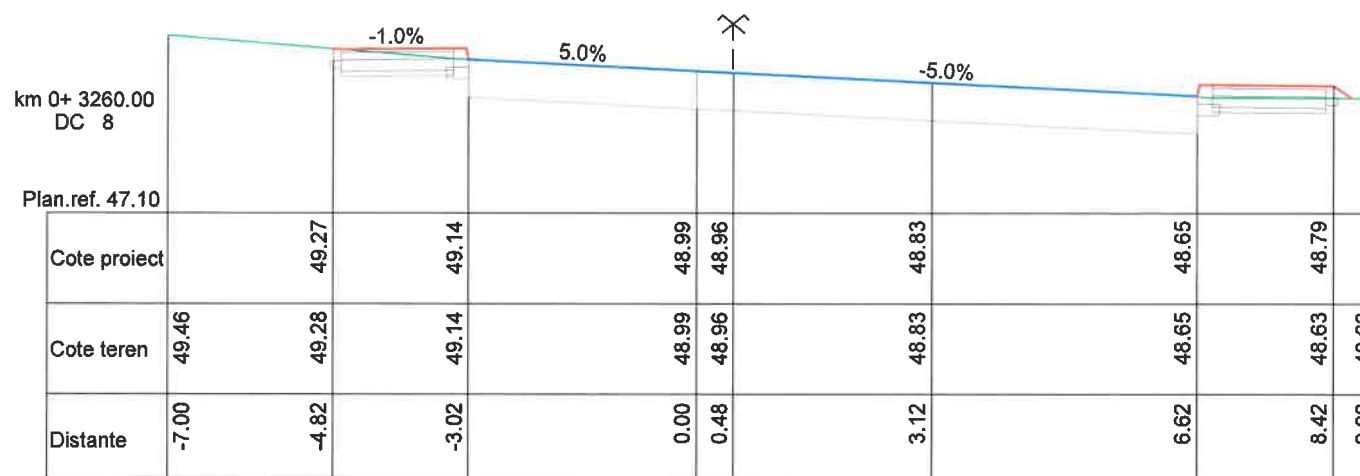
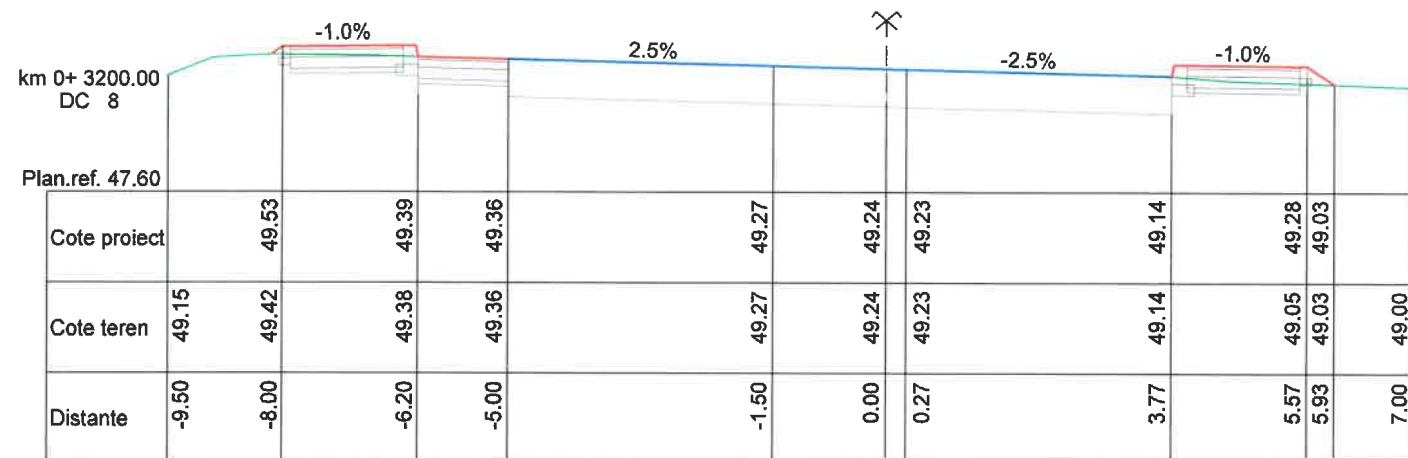
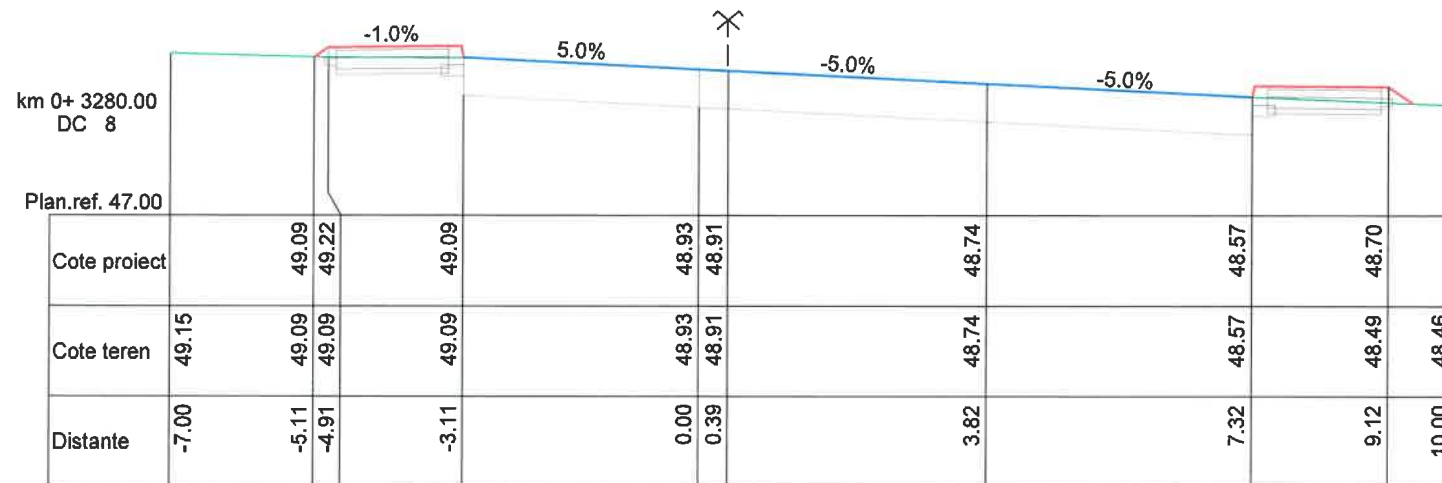
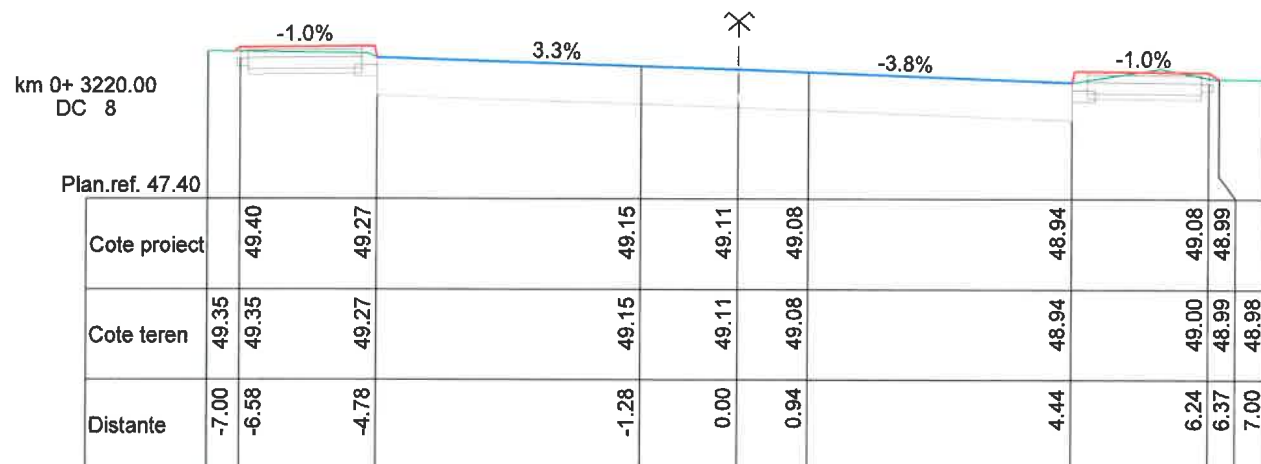
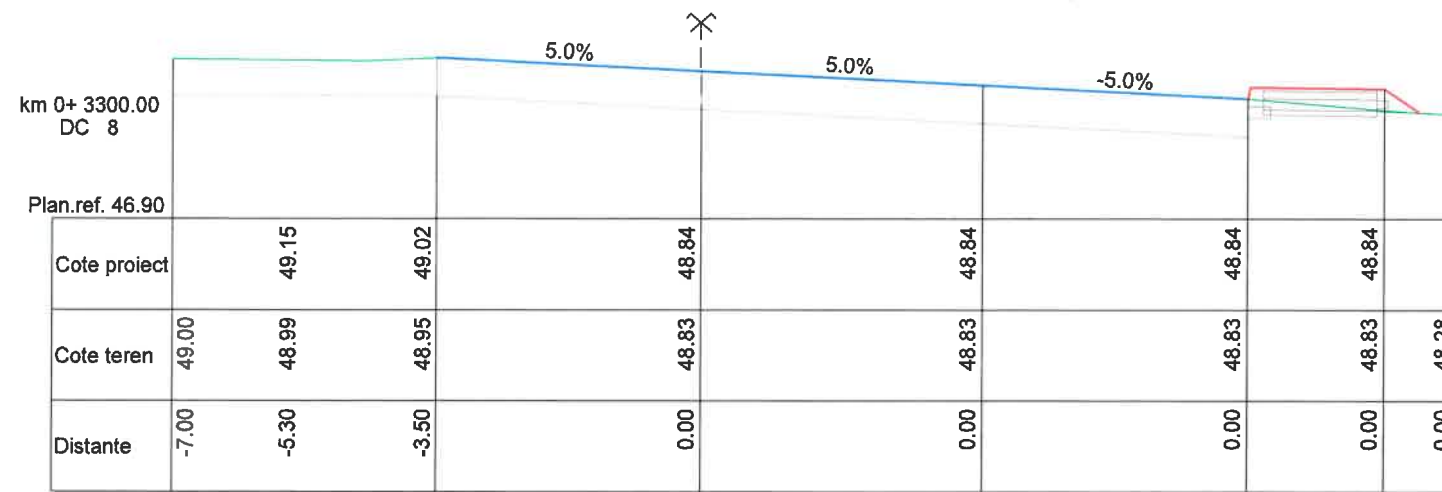
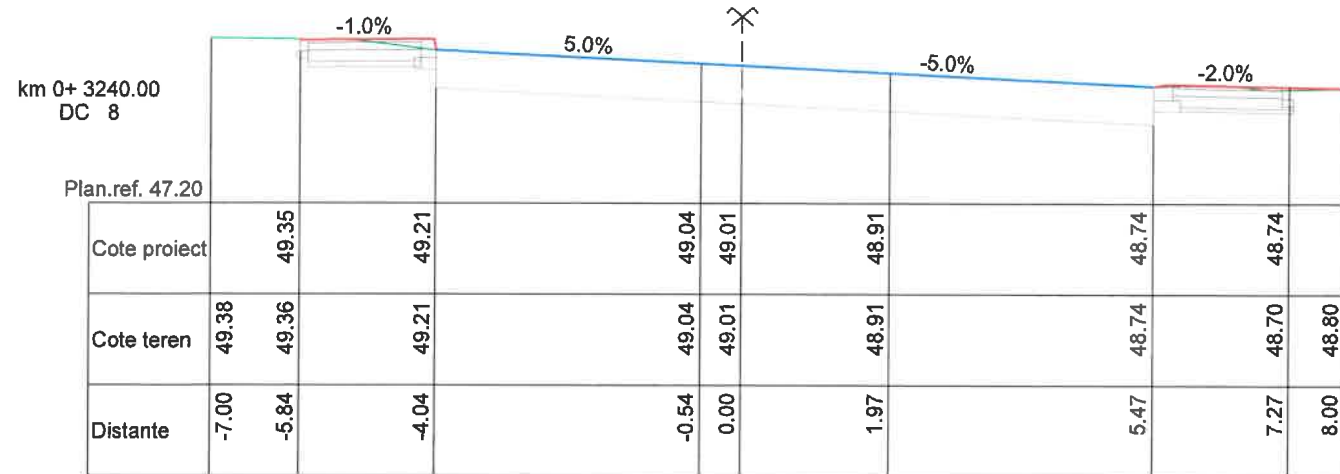

Verificator	Nume	Semnatura	Cerinta	Referat nr./data
Proiectant: 1ENGINEERING				Beneficiar: COMUNA LIMANU, JUDEȚUL CONSTANȚA
1ENGINEERING SRL • RO28725629 • J13/1567/2011 • CONSTANȚA, B-DUL TOMIS, NR.143A				Proiect nr. 241/2024
Scara: 1:100				Faza: P.T.+D.E.
Sef proiect	ing.Sorin PANA		Data: APRILIE 2024	ASIGURAREA INFRASTRUCTURII PENTRU TRANSPORT VERDE - PISTA DE BICICLETE IN COMUNA LIMANU, JUDEȚUL CONSTANTA
Proiectat	ing.Andreea ANTOHI			
Verificat	ing.Sorin PANA			
SECTIUNI TRANSVERSALE DC8 PISTA BICICLETE - TRASEU DUS - INTORS				Plansa nr. T.12

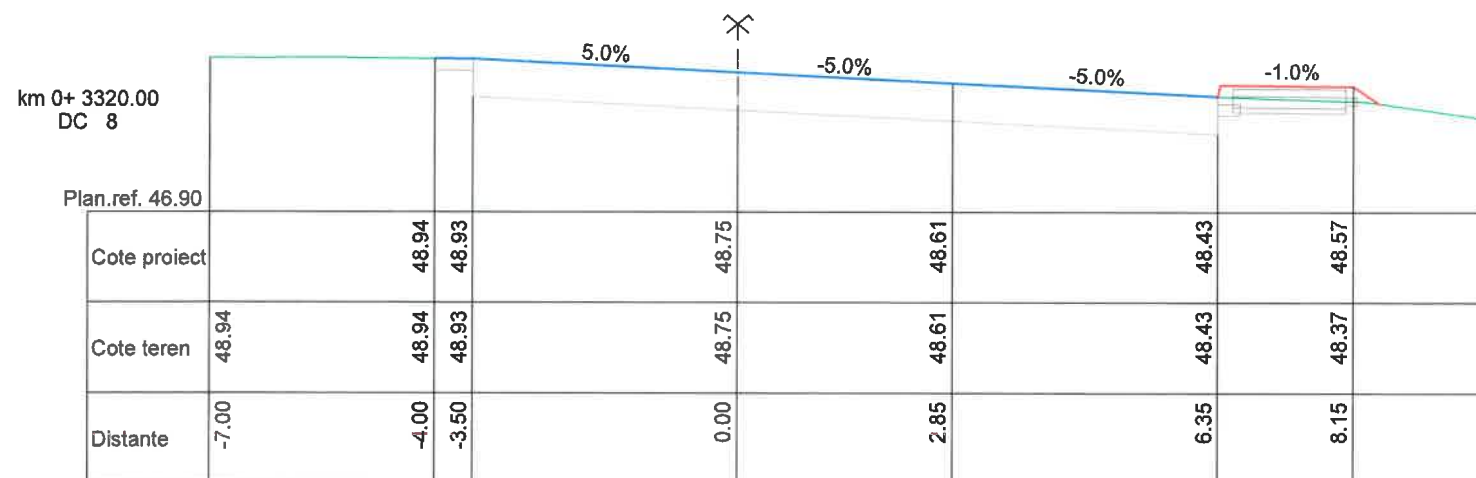
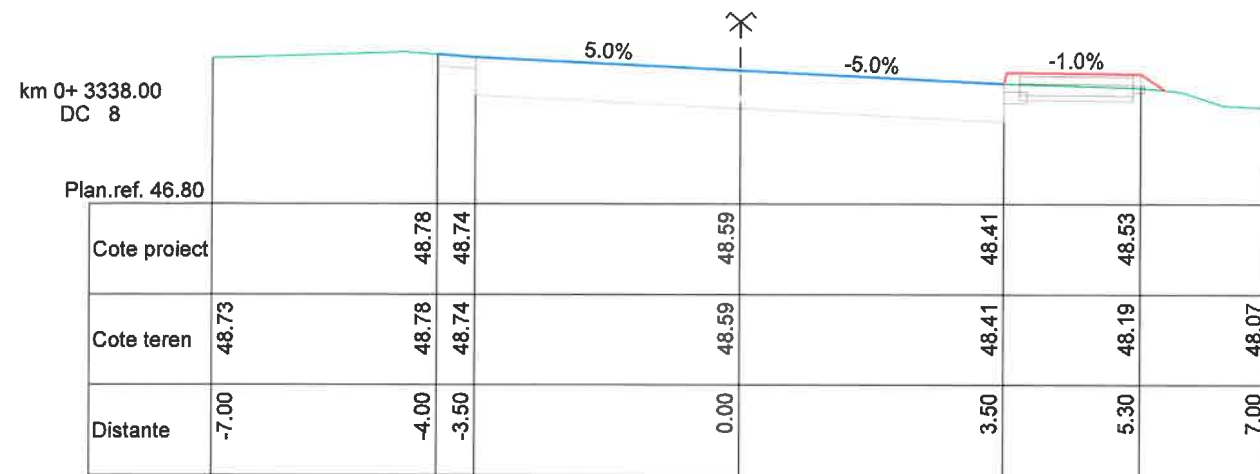

Verificator	Nume	Semnatura	Cerinta	Referat nr./data
Proiectant:	1ENGINEERING		Beneficiar:	COMUNA LIMANU, JUDEȚUL CONSTANȚA
1ENGINEERING SRL • RO28725629 • J13/1567/2011 • CONSTANTA, B-DUL TOMIS NR.143A			Scara	ASIGURAREA INFRASTRUCTURII PENTRU TRANSPORT VERDE - PISTA DE BICICLETE IN COMUNA LIMANU, JUDEȚUL CONSTANTA
Sef proiect	ing.Sorin PANA		1:100	Faza: P.T.+D.E.
Proiectat	ing.Andreea ANTOHI		Data	SECTIUNI TRANSVERSALE DC8 PISTA BICICLETE - TRASEU DUS - INTORS
Verificat	ing.Sorin PANA		APRILIE 2024	Planșa nr. T.13

PLAN COFRAJ ZID SPRIJIN TIP "L" H=1.35m

SECTIUNE A - A

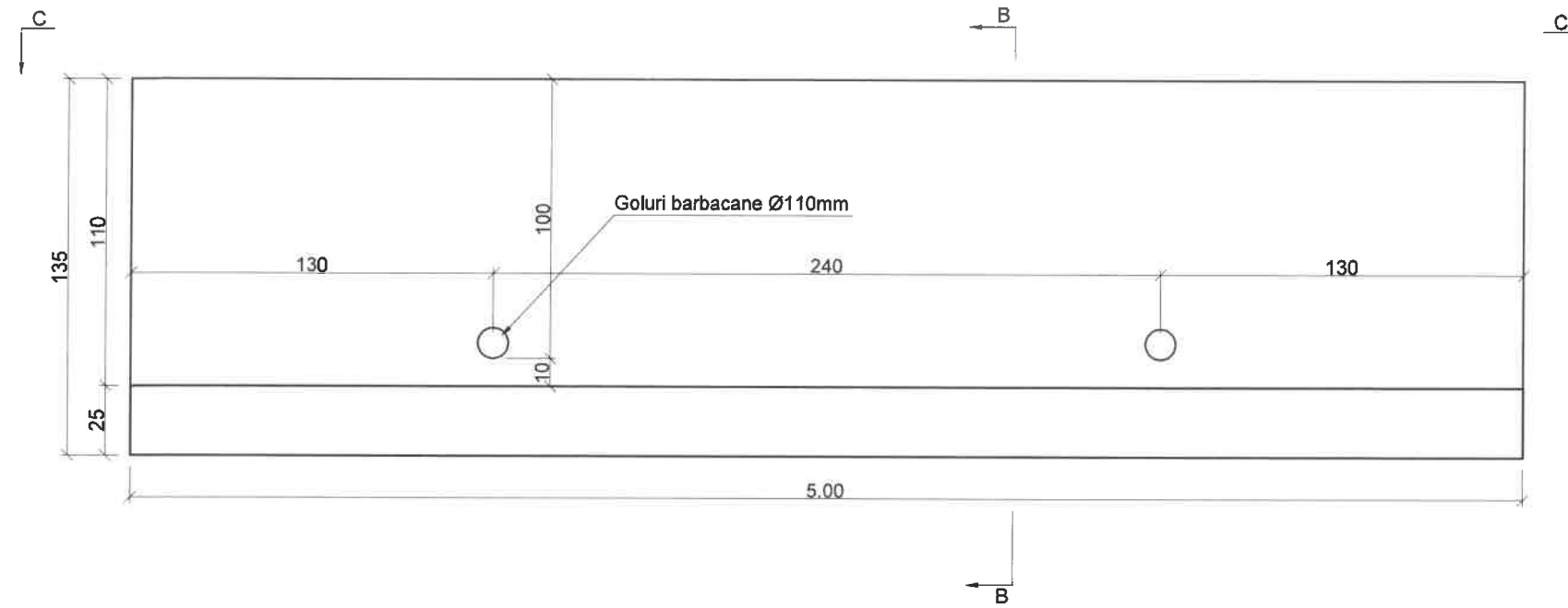

SECTIUNE B - B

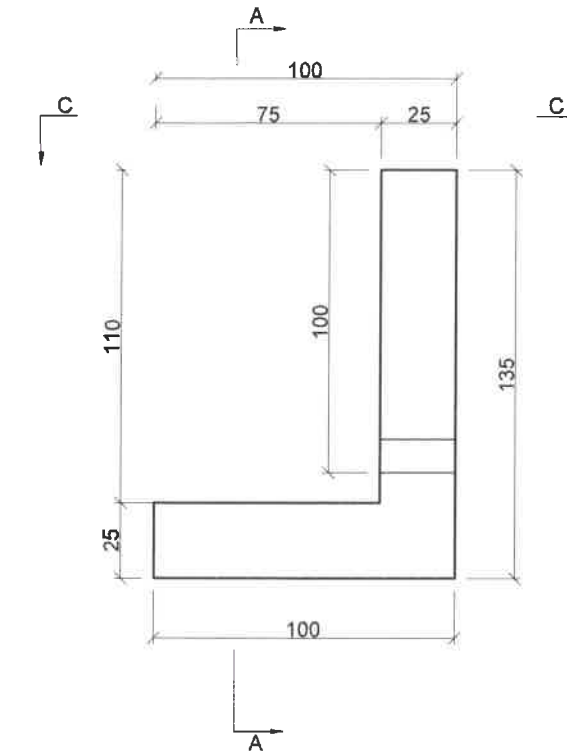

SECTIUNE C - C

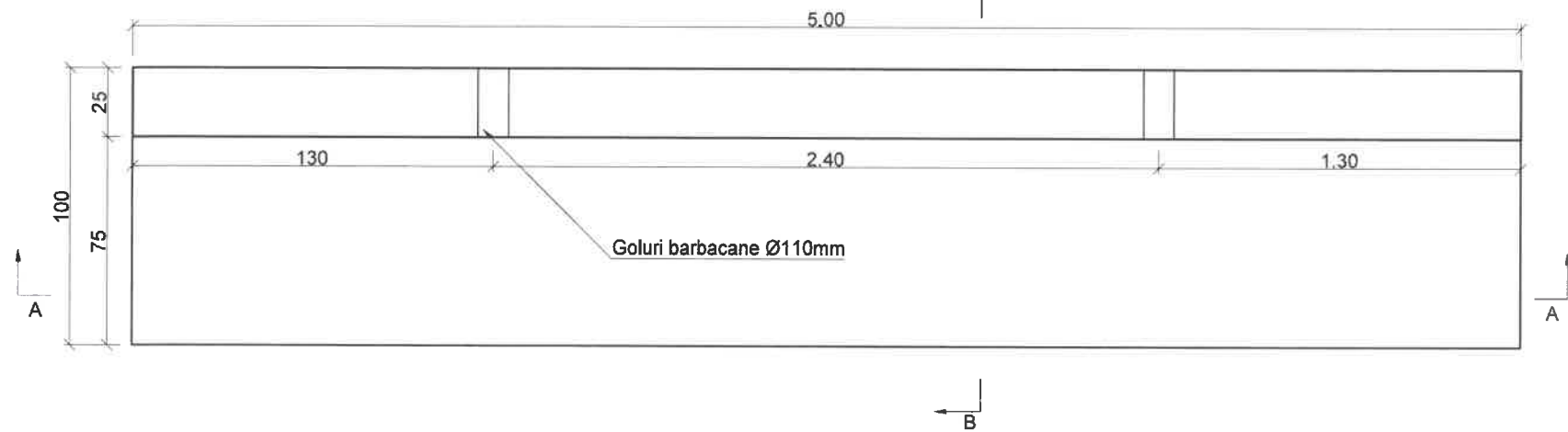

BETON C25/30: 2.63mc

BETON	C25/30
- CLASA DE EXPUNERE	= XC4
- GRAD DE IMPERMEABILITATE (min.)	= P4
- TIP CIMENT	= I A 52.5
- RAPORT APA/CIMENT (max.)	= 0.5

Verificator	Nume	Semnatura	Cerinta	Referat nr./data
Proiectant:	1 ENGINEERING			Beneficiar: COMUNA LIMANU, JUDEȚUL CONSTANȚA
				Proiect nr. 241/2024
			Scara 1:50	Faza: P.T.+D.E.
Sef proiect	ing.Sorin PANA	<i>[Signature]</i>		
Proiectat	ing.Andreea ANTOHI	<i>[Signature]</i>	Data	
Verificat	ing.Sorin PANA	<i>[Signature]</i>	APRILIE 2024	
				ASIGURAREA INFRASTRUCTURII PENTRU TRANSPORT VERDE - PISTA DE BICICLETE IN COMUNA LIMANU, JUDEȚUL CONSTANTA
				DETALIU COFRAJ ZID DE SPRIJIN TIP "L" H = 1,35 m
				Plansa nr. Zid1.01

NOTA:

1. Dupa decofrare peretii exteriori care vor fi in contact cu terasamentele se vor vopsi cu solutie de bitum filerizat in doua straturi.
2. orice modificare a prezentei planse se face numai cu acordul scris al proiectantului.
3. Orice neconcordanta dintre prevederile acestei planse si situatia din amplasament, se va aduce la cunostinta proiectantului.
4. Plansele Zid01.1 si Zid01.2 se citesc impreuna.

PLAN ARMARE ZID SPRIJIN TIP "L" H=1.35 m
SECTIUNE A - A

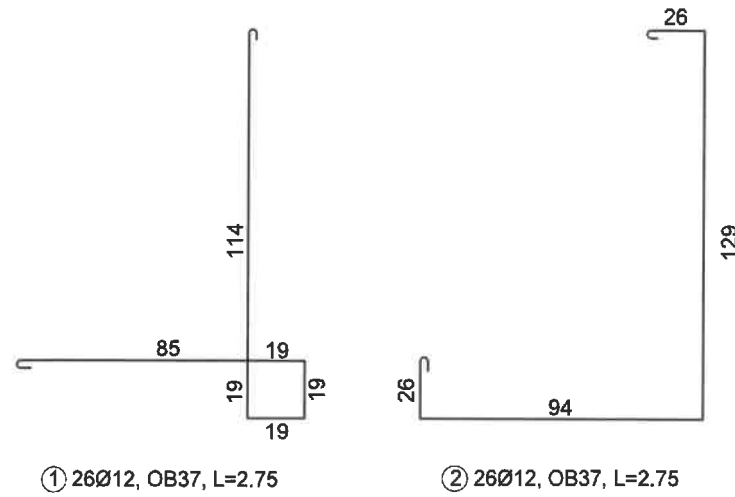
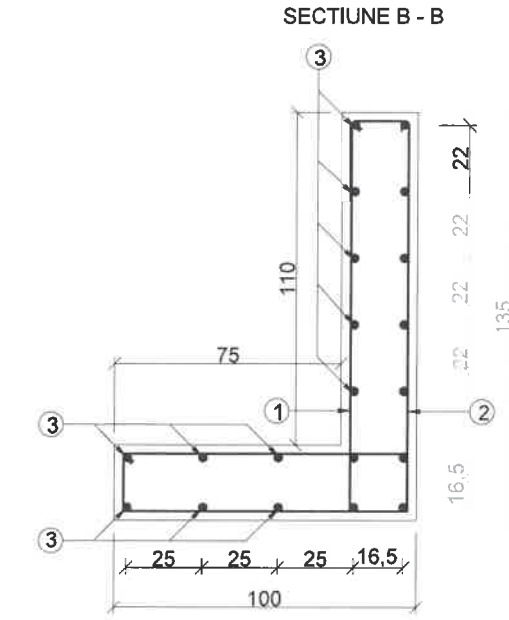
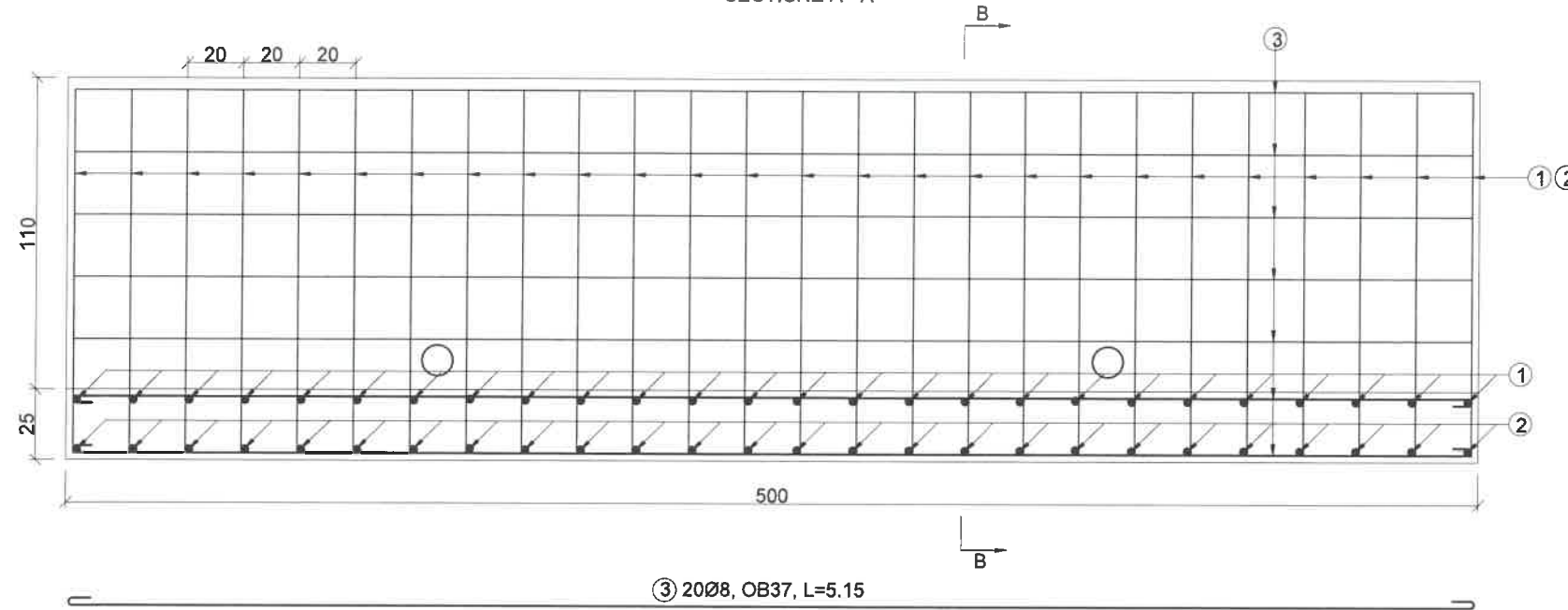

EXTRAS ARMATURA ZID SPRIJIN H=1,35 m, tronson 5 m

Marca	Ø	Buc.	Lung. pe buc.	Lungimi / Ø	
				Ø8	Ø12
1	12	26	2.75		71.50
2	12	26	2.75		71.50
3	8	20	5.15	103.0	
Lungimi/Ø				103.0	143.0
Greutate pe ml				0.395	0.888
Greutate pe Ø				41.0	127.0
Greutate/OB37				168.0	

NOTA:

- Orice modificare a prezentei planse se face numai cu acordul scris al proiectantului.
- Orice neconcordanță dintre prevederile acestei planse și situația din amplasament, se va aduce la cunoștința proiectantului.

Verificator	Nume	Semnatura	Cerinta	Referat nr./data
Proiectant:	1 ENGINEERING		Beneficiar:	COMUNA LIMANU, JUDEȚUL CONSTANȚA
1ENGINEERING SRL • RO28725629 • J13/1567/2011 • CONSTANTA, B-DUL TOMIS, NR.143				Proiect nr. 241/2024
Sef proiect	ing.Sorin PANA	<i>[Signature]</i>	Scara 1:50	Faza: P.T.+D.E.
Proiectat	ing.Andreea ANTOHI	<i>[Signature]</i>	Data APRILIE 2024	Planșa nr. Zid1.02
Verificat	ing.Sorin PANA	<i>[Signature]</i>		

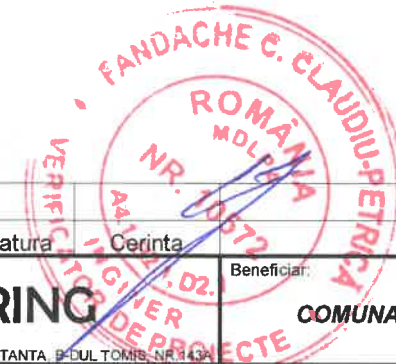

PLAN COFRAJ ZID SPRIJIN TIP "L" H=1.00 m

SECTIUNE A - A

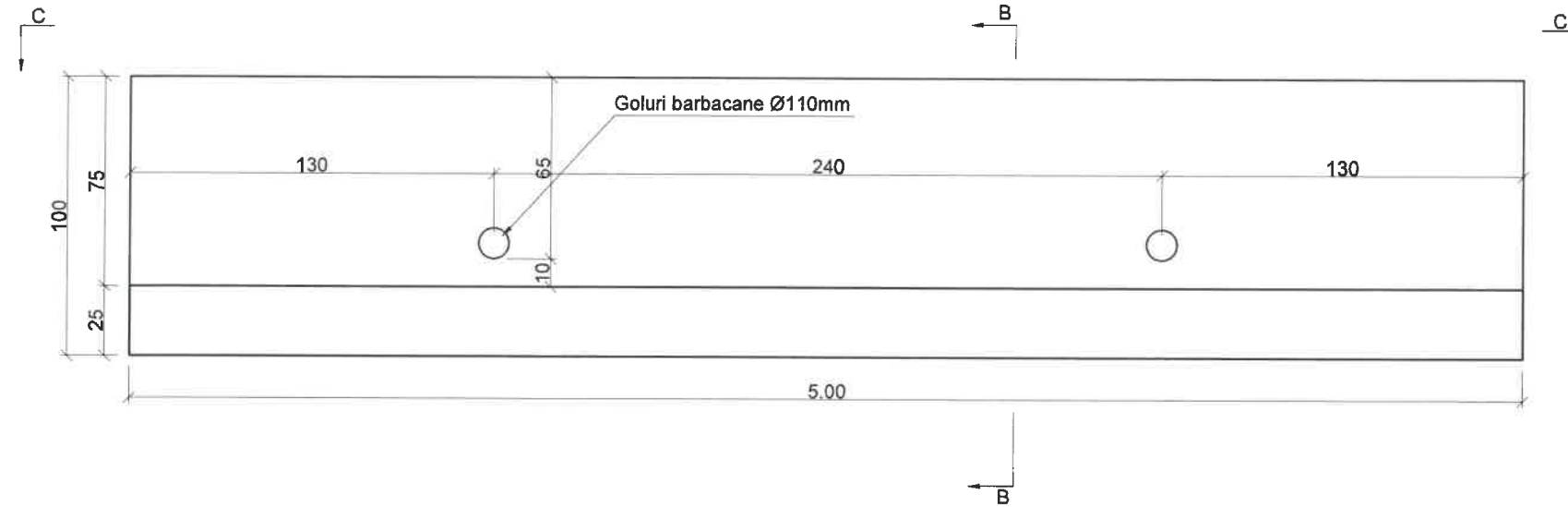

SECTIUNE B - B

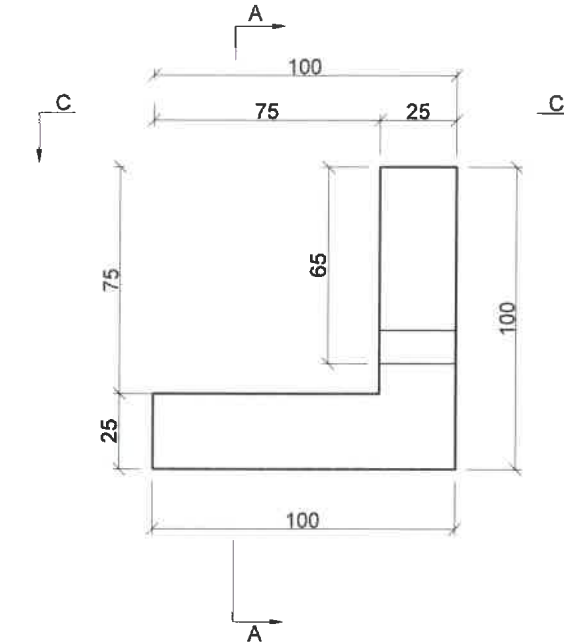

SECTIUNE C - C

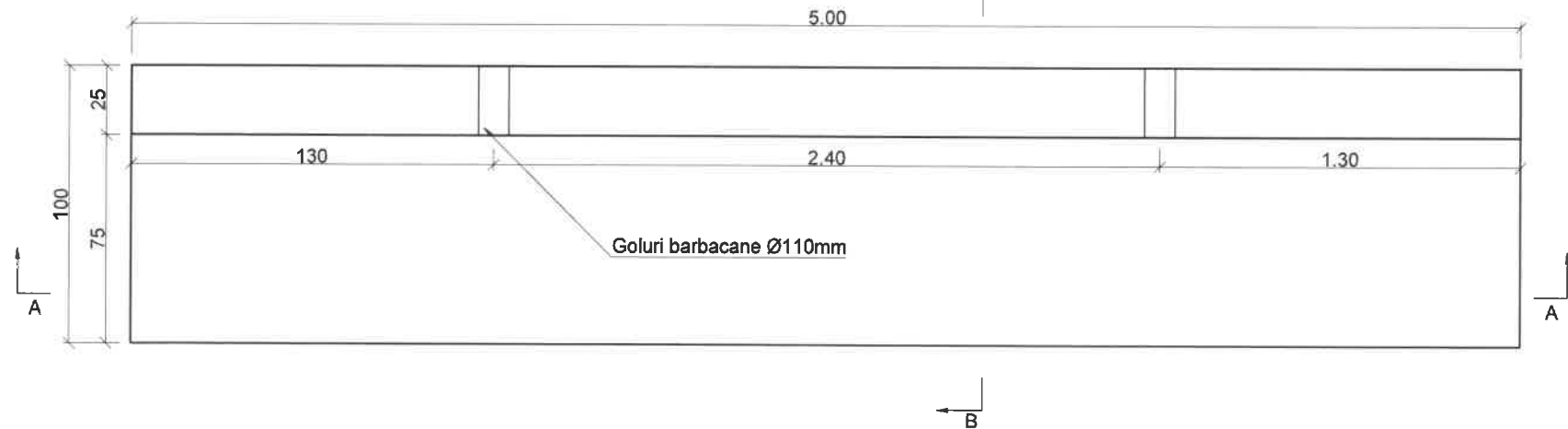

BETON C25/30: 2.20mc

BETON	C25/30
- CLASA DE EXPUNERE	= XC4
- GRAD DE IMPERMEABILITATE (min.)	= P4
- TIP CIMENT	= I A 52.5
- RAPORT APA/CIMENT (max.)	= 0.5

NOTA:

1. Dupa decofrare peretii exteriori care vor fi in contact cu terasamentele se vor vopsi cu solutie de bitum filerizat in doua straturi.
2. orice modificare a prezentei planse se face numai cu acordul scris al proiectantului.
3. Orice neconcordanta dintre prevederile acestei planse si situatia din amplasament, se va aduce la cunostinta proiectantului.
4. Plansele Zid02.1 si Zid02.2 se citesc impreuna.

Verificator	Nume	Semnatura	Cerinta	Referat nr./data	
Proiectant:	1ENGINEERING			Beneficiar:	Proiect nr. 241/2024
	1ENGINEERING SRL • RO28725629 • J13/1567/2011 • CONSTANTA, B-DUL TOMIS, NR.143A			COMUNA LIMANU, JUDEȚUL CONSTANȚA	
			Scara 1:50	ASIGURAREA INFRASTRUCTURII PENTRU TRANSPORT VERDE - PISTA DE BICICLETE IN COMUNA LIMANU, JUDEȚUL CONSTANTA	Faza: P.T.+D.E.
Sef proiect	ing.Sorin PANA	<i>[Signature]</i>		DETALIU COFRAJ ZID DE SPRIJIN TIP "L" H = 1,00 m	Plansa nr. Zid2.01
Proiectat	ing.Andreea ANTOHI	<i>[Signature]</i>			
Verificat	ing.Sorin PANA	<i>[Signature]</i>	Data APRILIE 2024		

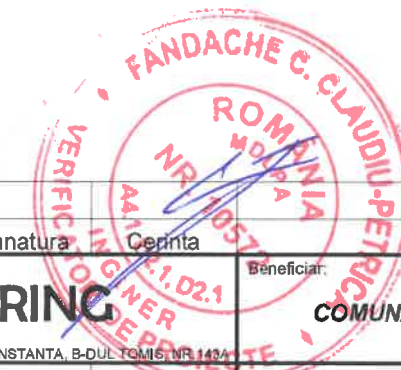

PLAN ARMARE ZID SPRIJIN TIP "L" H=1.00 m

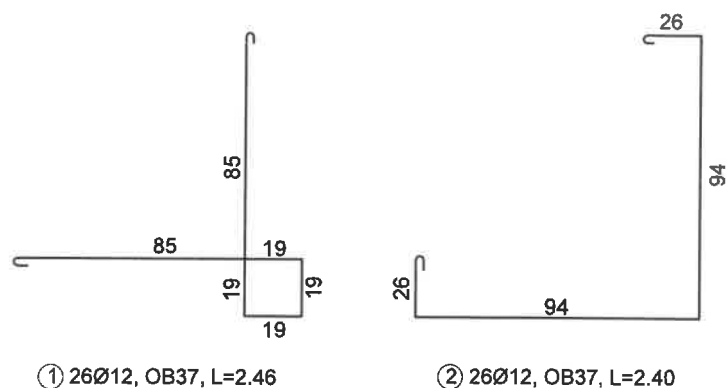
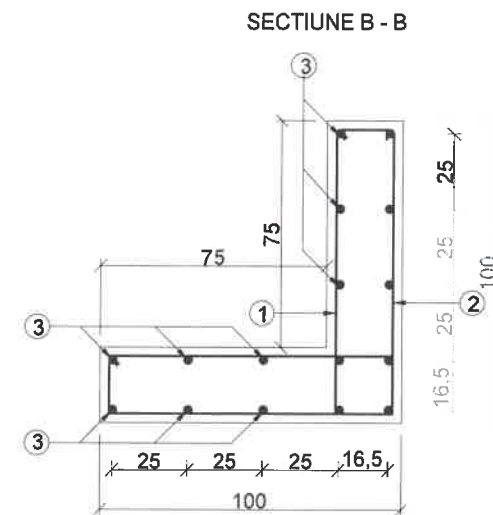
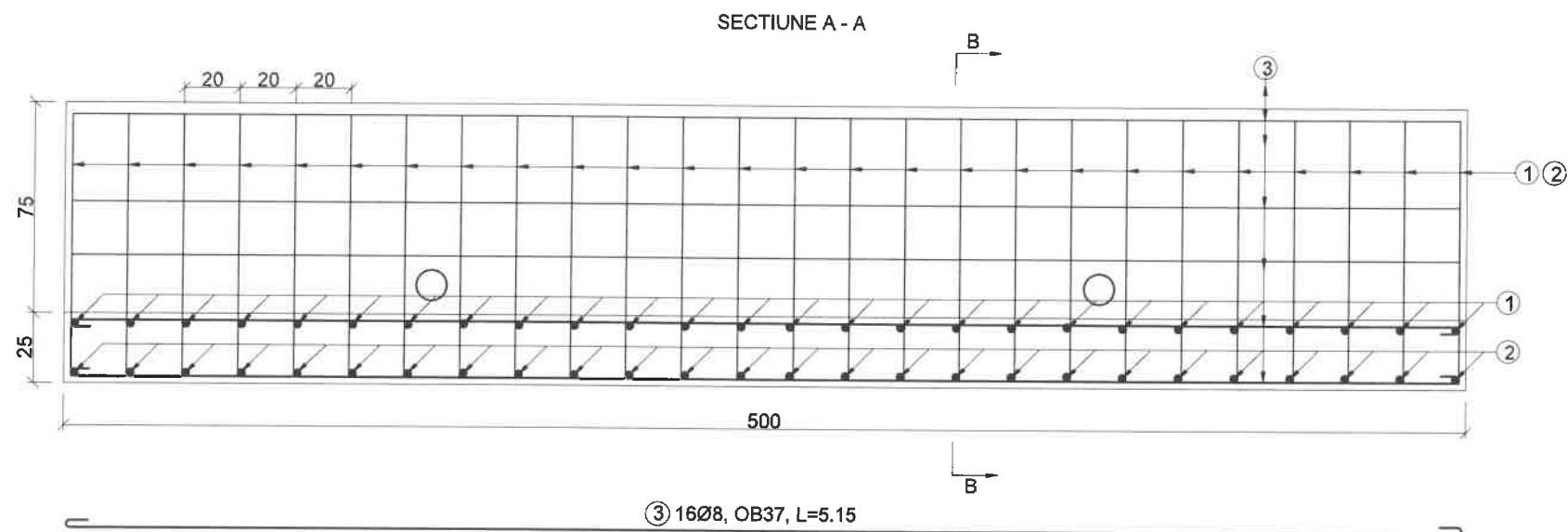

EXTRAS ARMATURA ZID SPRIJIN H=1,00 m, tronson 5 m

Marca	Ø	Buc.	Lung. pe buc.	Lungimi / Ø	
				Ø8	Ø12
1	12	26	2.46		64.00
2	12	26	2.40		62.40
3	8	16	5.15	82.40	
Lungimi/Ø				82.40	126.40
Greutate pe ml				0.395	0.888
Greutate pe Ø				33.00	113.00
Greutate/OB37				146.00	

NOTA:

- Orice modificare a prezentei planse se face numai cu acordul scris al proiectantului.
- Orice neconcordanță dintre prevederile acestei planse și situația din amplasament, se va aduce la cunoștința proiectantului.

Verificator	Nume	Semnatura	Cerinta	Referat nr./data
Proiectant:	1 ENGINEERING			Beneficiar: COMUNA LIMANU, JUDEȚUL CONSTANȚA
1ENGINEERING SRL • RO28725629 • J13/1567/2011 • CONSTANTA, B-DUL TOMIS, NR.143A				Proiect nr. 241/2024
Sef proiect	ing.Sorin PANA	<i>[Signature]</i>	Scara 1:50	Faza: P.T.+D.E.
Proiectat	ing.Andreea ANTOHI	<i>[Signature]</i>	Data APRILIE 2024	Plansa nr. Zid2.02
Verificat	ing.Sorin PANA	<i>[Signature]</i>		



DETALIU PISTA BICICLETE ACCESURI PROPRIETATI

Sc. 1:20

PISTA DE BICICLETE
1,80

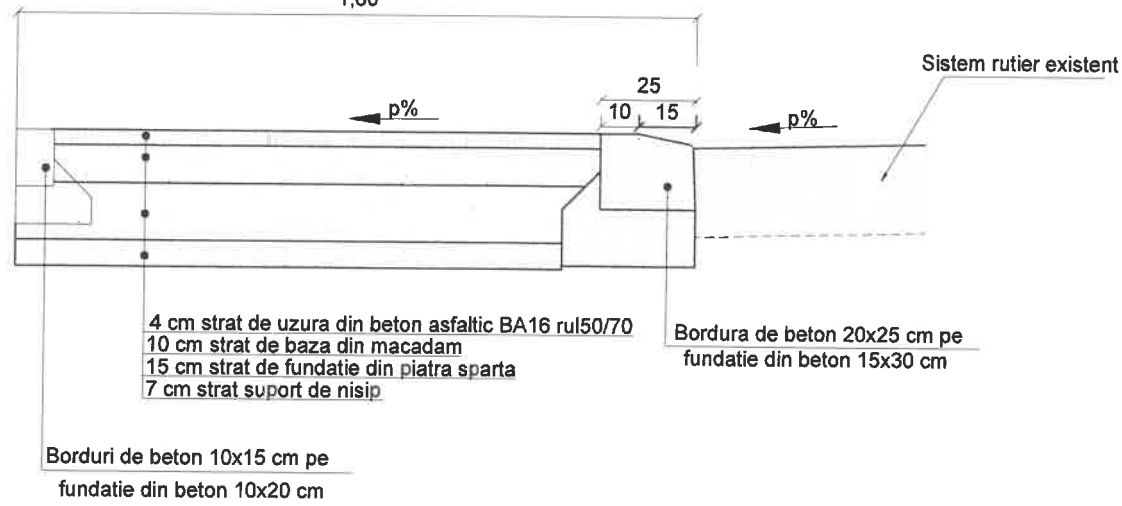

AMENAJARE PISTA BICICLETE ACCESURI PROPRIETATI

Scara 1:50

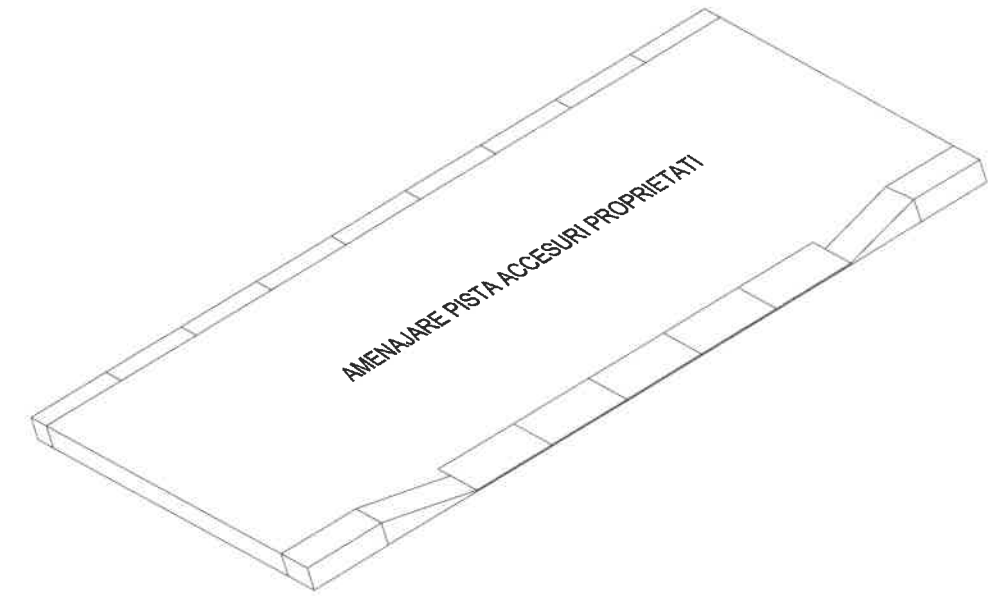

DETALIU BORDURA MARE

Sc. 1:20

VEDERE LATERALA A-A

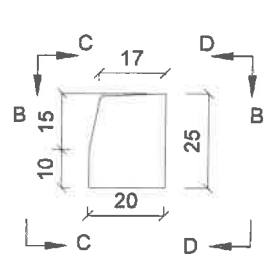

VEDERE DE SUS B-B

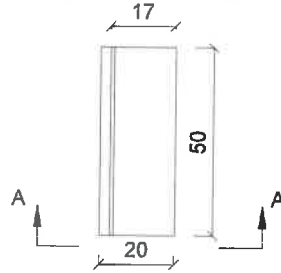

VEDERE LATERALA C-C

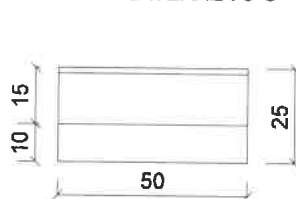

VEDERE LATERALA D-D

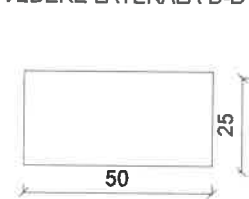

DETALIU BORDURA MICA

Sc. 1:20

VEDERE LATERALA A-A

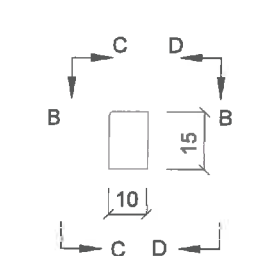

VEDERE DE SUS B-B

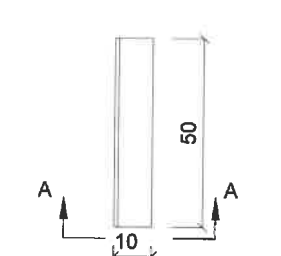

VEDERE LATERALA C-C

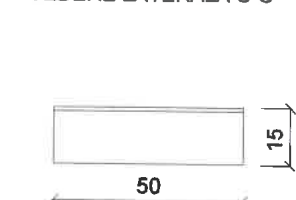

VEDERE LATERALA D-D



DETALIU BORDURA RACORD

Sc. 1:20

VEDERE LATERALA A-A

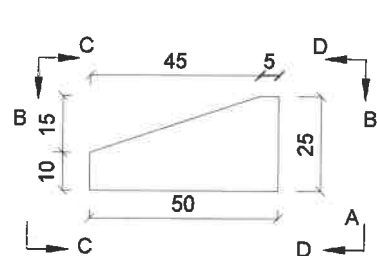

VEDERE DE SUS B-B

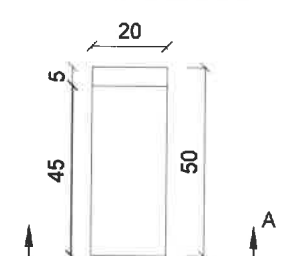

VEDERE LATERALA C-C

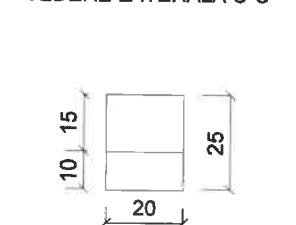

VEDERE LATERALA D-D

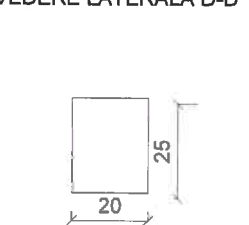

AMENAJARE PISTA BICICLETE ACCESURI PROPRIETATI

VEDERE DE SUS

Scara 1:50

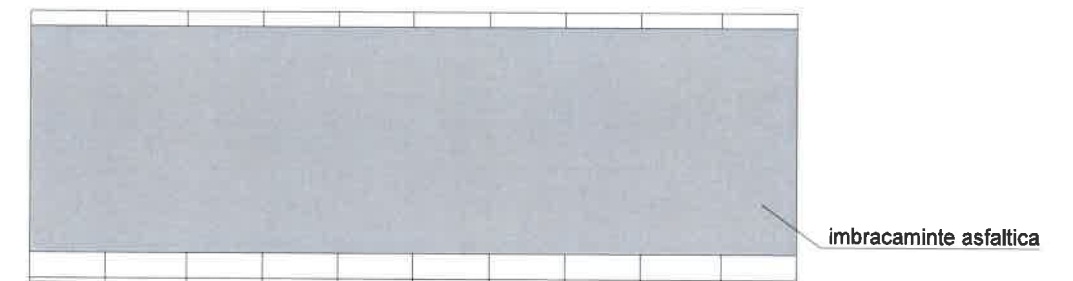

Verificator	Nume	Semnatura	Cerinta	Referat nr./data
Proiectant:	1ENGINEERING		Beneficiar:	COMUNA LIMANU, JUDEȚUL CONSTANȚA
1ENGINEERING SRL • RO28725629 • J13/1567/2011 • CONSTANTA, B-DOL TOMIS, NR.143A			Scara	Proiect nr. 241/2024
Sef proiect	ing.Sorin PANA	<i>[Signature]</i>	1:20, 1:50	Faza: P.T.+D.E.
Proiectat	ing.Andreea ANTOHI	<i>[Signature]</i>	Data	DETALIU PISTA BICICLETE ACCESURI PROPRIETATI
Verificat	ing.Sorin PANA	<i>[Signature]</i>	APRILIE 2024	

DETALIU PISTA BICICLETE AMPLASARE TEAVA PVC 110x3.2 mm, SN4
Sc. 1:20

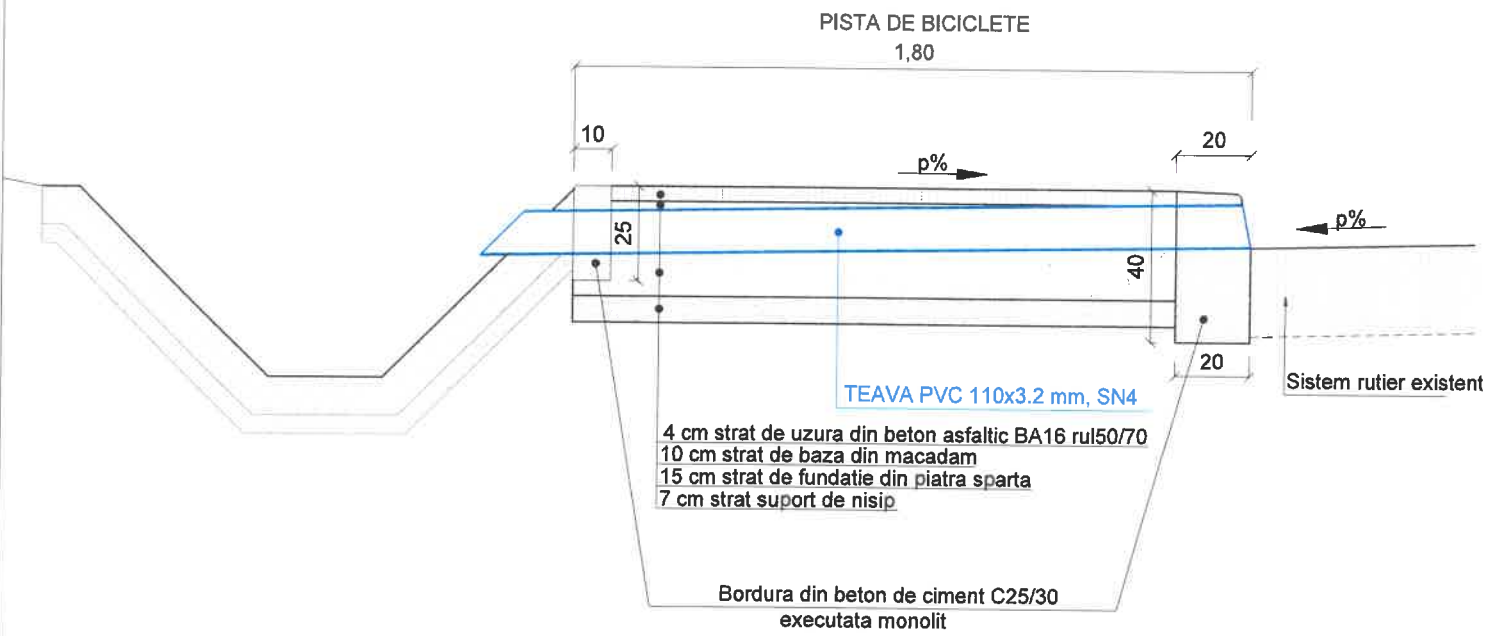

MODEL TIP AMPLASARE 2 x TEAVA PVC 110X3.2 mm
Scara 1:50

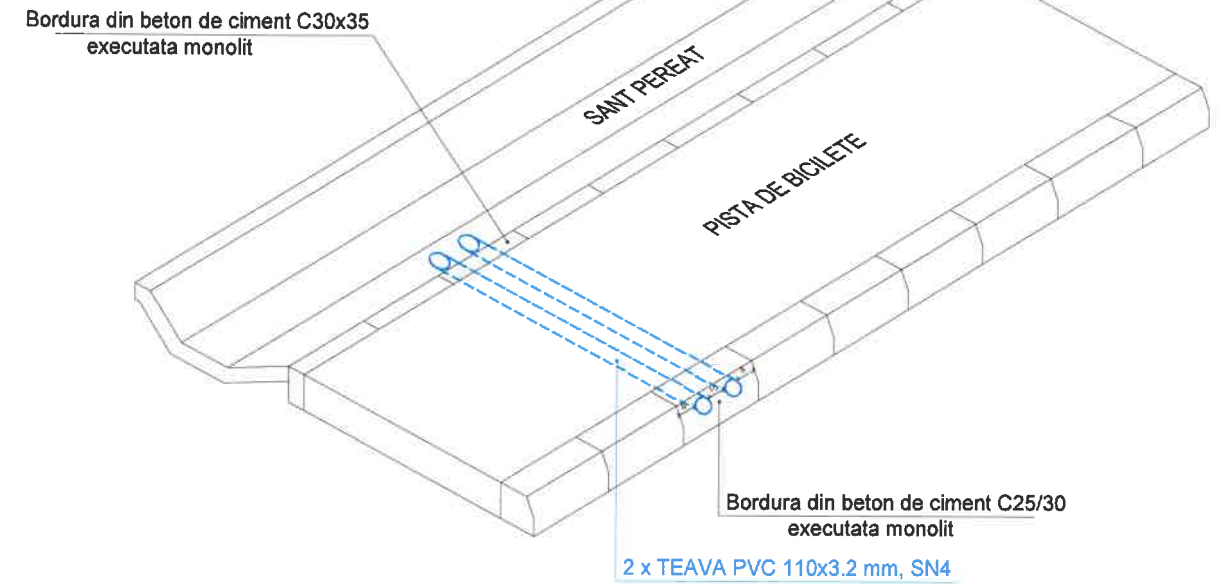

DETALIU BORDURA MARE MONOLITA
Sc. 1:20

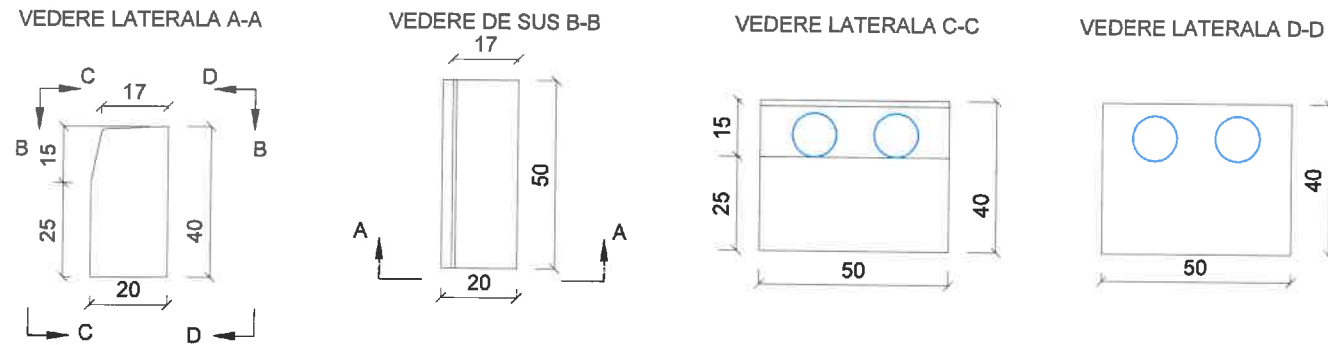

DETALIU BORDURA MICA MONOLITA
Sc. 1:20

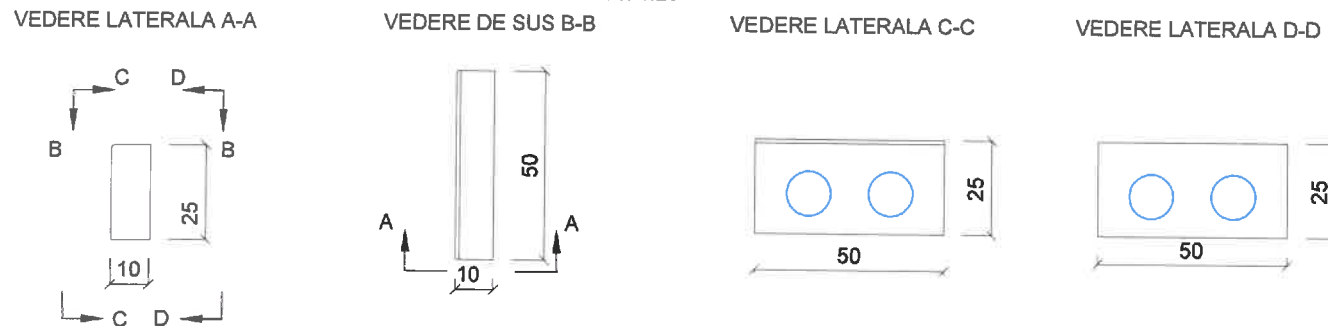

MODEL TIP AMPLASARE 2 x TEAVA PVC 110X3.2 mm
VEDERE DE SUS
Scara 1:50

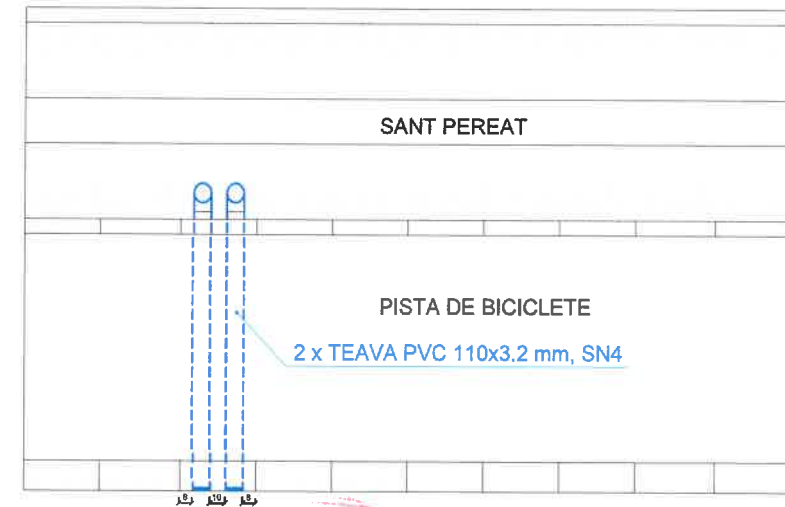

BORDURA MARE: BETON C25/30: 0.078 mc/m
BORDURA MARE: BETON C25/30: 0.025 mc/m

BETON	C25/30
- CLASA DE EXPUNERE	= XC4
- GRAD DE IMPERMEABILITATE (min.)	= P4
- TIP CIMENT	= I A 52.5
- RAPORT APA/CIMENT (max.)	= 0.5

Nota: Pozitia tevilor in plan se va adapta in functie de situatia existenta in teren

Verificator	Nume	Semnatura	Cerinta	Referat nr./data
Proiectant:	1ENGINEERING			Beneficiar: COMUNA LIMANU, JUDEȚUL CONSTANȚA
1ENGINEERING SRL • RO28725629 • J13/1567/2011 • CONSTANȚA, B-BOUL TOMIS, NR.143A				Proiect nr. 241/2024
Sef proiect	ing.Sorin PANA	<i>[Signature]</i>	Scara 1:20, 1:50	Faza: P.T.+D.E.
Proiectat	ing.Andreea ANTOHI	<i>[Signature]</i>	Data APRILIE 2024	DETALIU AMPLASARE 2xTEAVA 110x3.2 mm
Verificat	ing.Sorin PANA	<i>[Signature]</i>		

SECTIUNE LONGITUDINALA A-A
Sc. 1:25

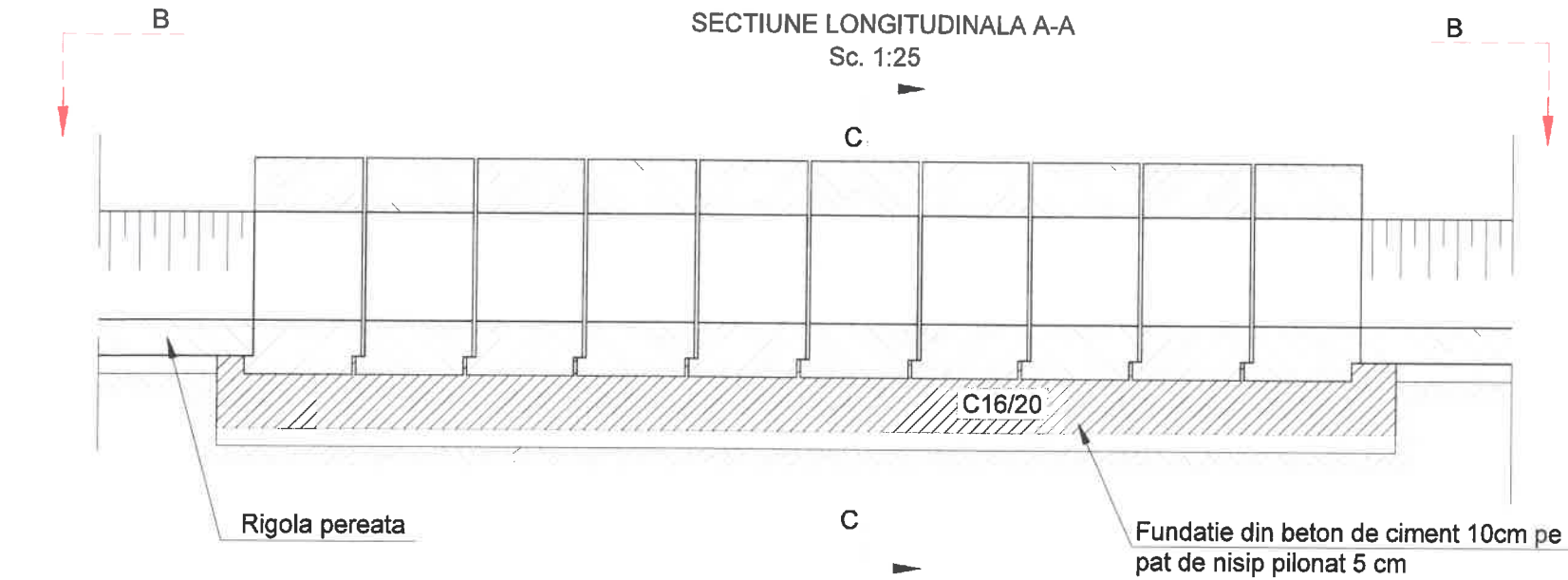

SECTIUNE C-C
SECTIUNE TRANSVERSALA
sc. 1:10

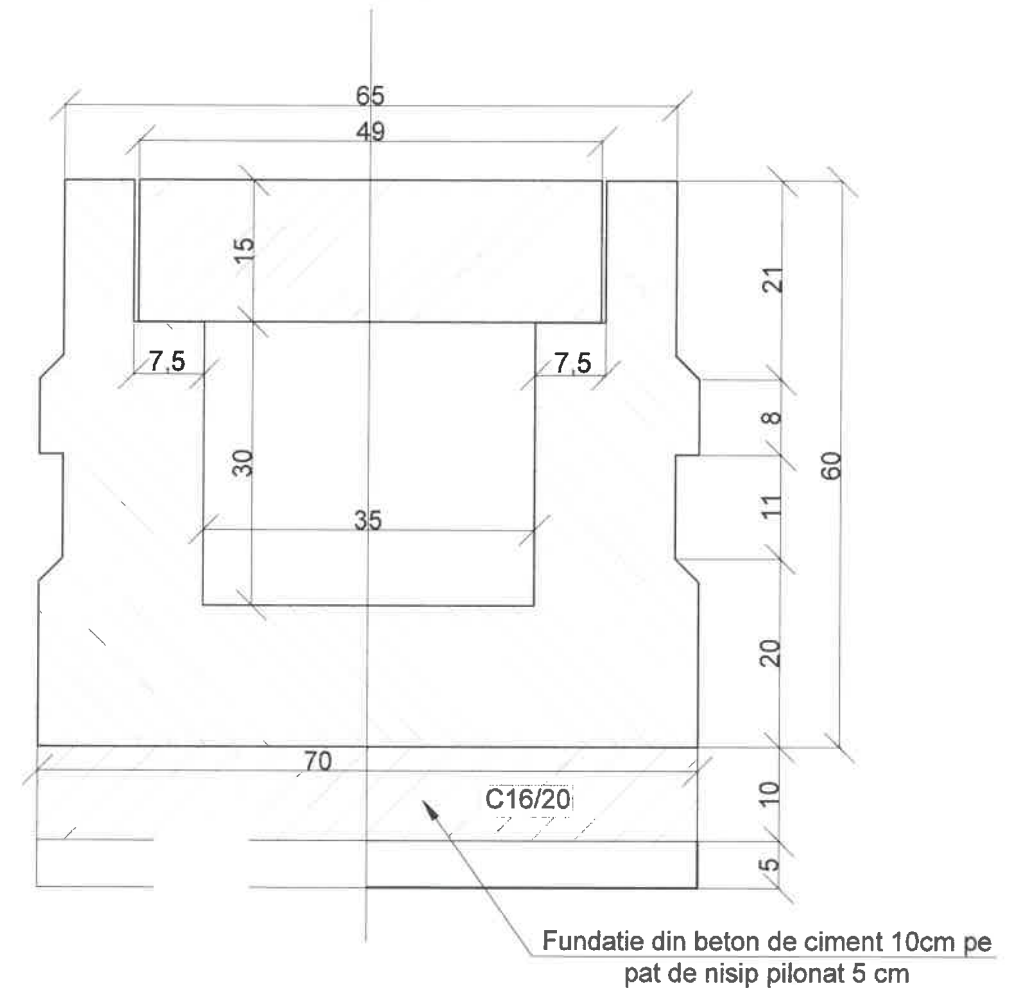

VEDERE B-B
VEDERE IN PLAN RIGOLA PREFABRICATA
Sc. 1:25

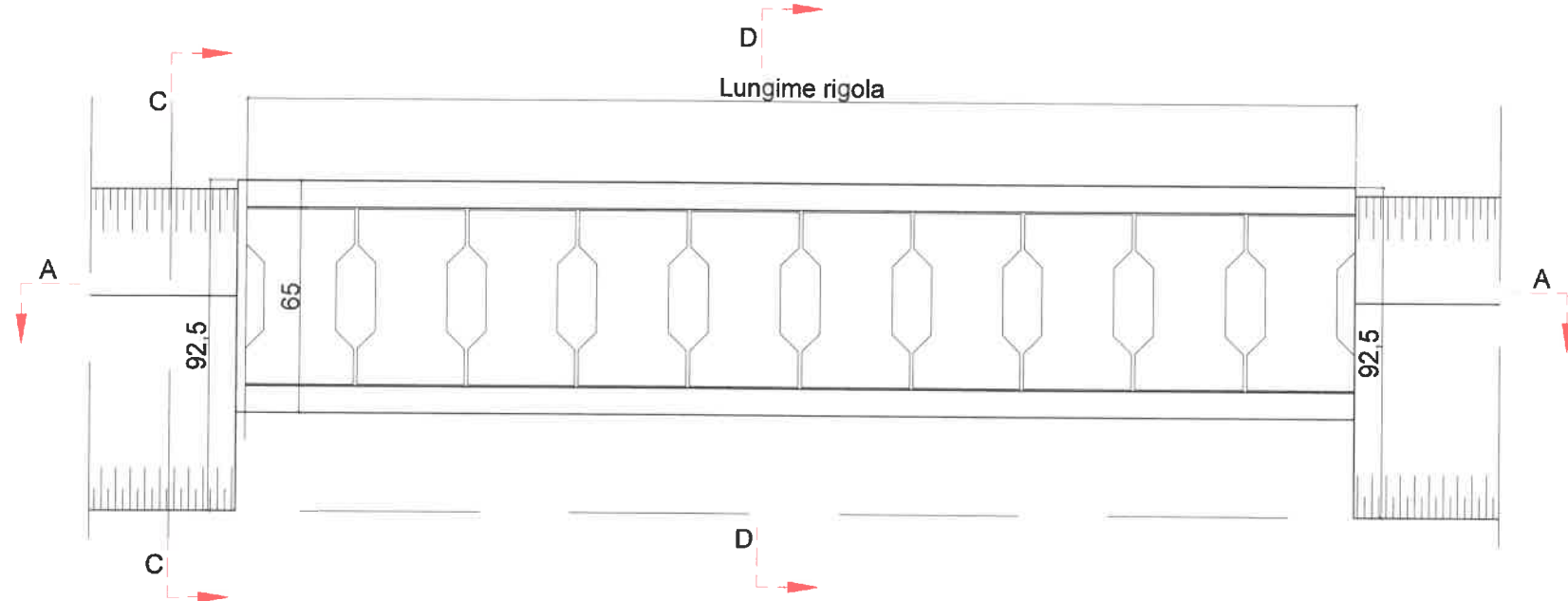

PLACUTA PREFABRICATA ARMATA DIN BETON
Sc. 1:10

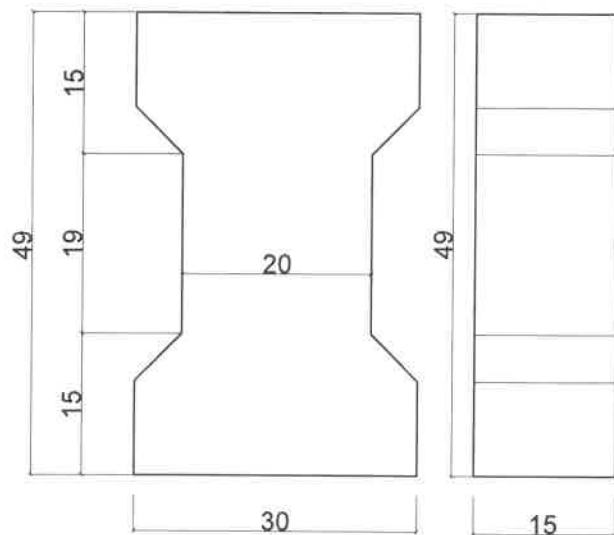

BETON	
- CLASA DE EXPUNERE	C16/20 = XC1
- GRAD DE IMPERMEABILITATE (min.)	= P4
- TIP CIMENT	= CEM I 42.5R
- RAPORT APA/CIMENT (max.)	= 0.5

Verificator	Nume	Semnatura	Cerinta	Referat nr./data
Proiectant:	1ENGINEERING		Beneficiar:	COMUNA LIMANU, JUDEȚUL CONSTANȚA
1ENGINEERING SRL • RO28725629 • J13/1567/2011 • CONSTANȚA, B-DUL TOMIS, NR.143A				Proiect nr. 241/2024
Sef proiect	ing.Sorin PANA	<i>[Signature]</i>	Scara 1:50	Faza: P.T.+D.E.
Proiectat	ing.Andreea ANTOHI	<i>[Signature]</i>	Data APRILIE 2024	DETALIU RIGOLA CAROSABILA ACCES PROPRIETATI
Verificat	ing.Sorin PANA	<i>[Signature]</i>		

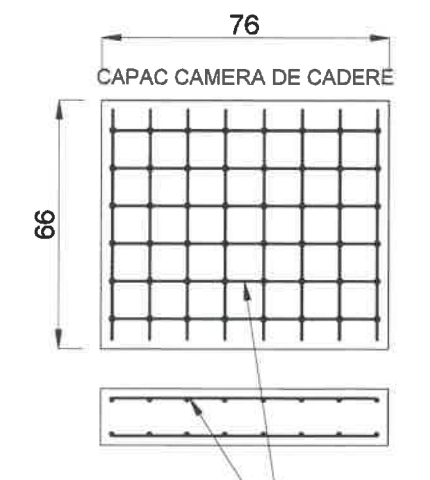
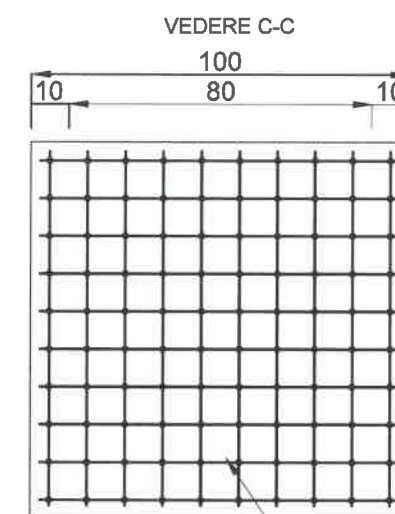
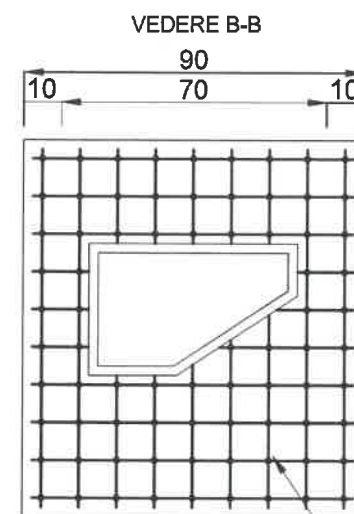
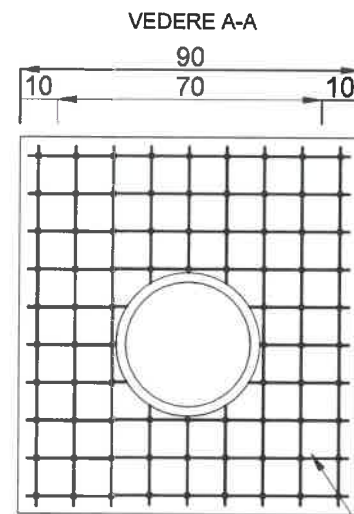
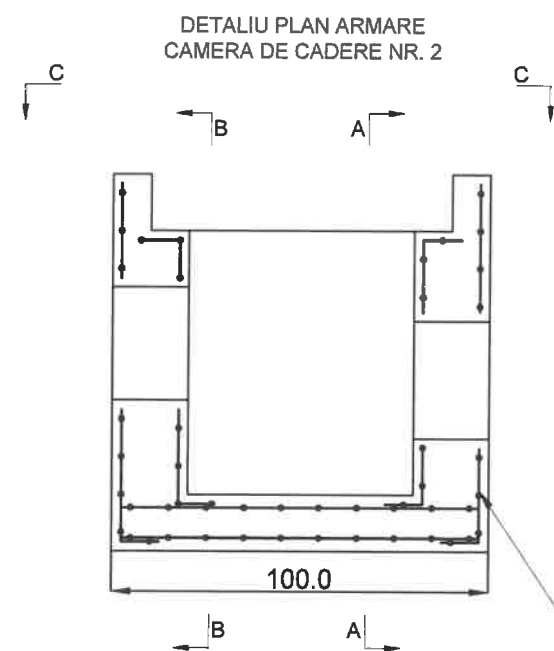
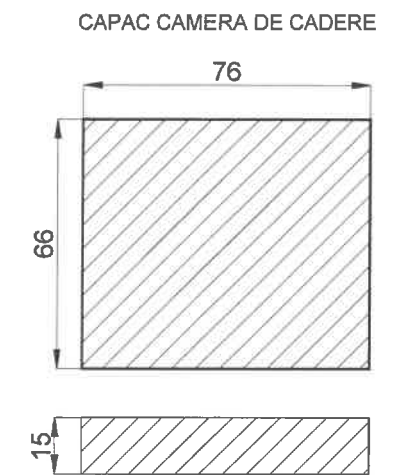
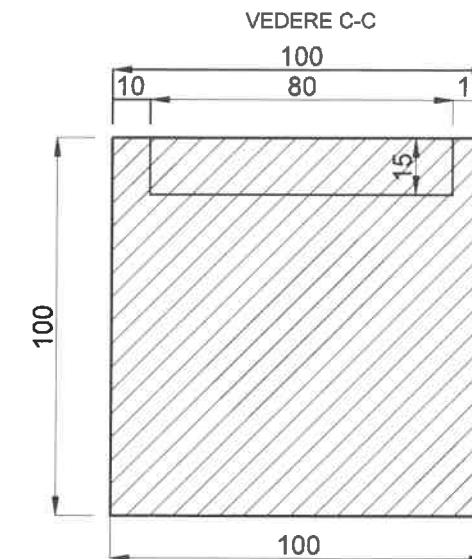
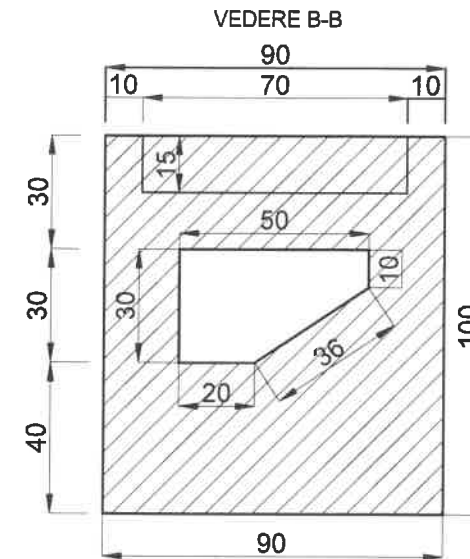
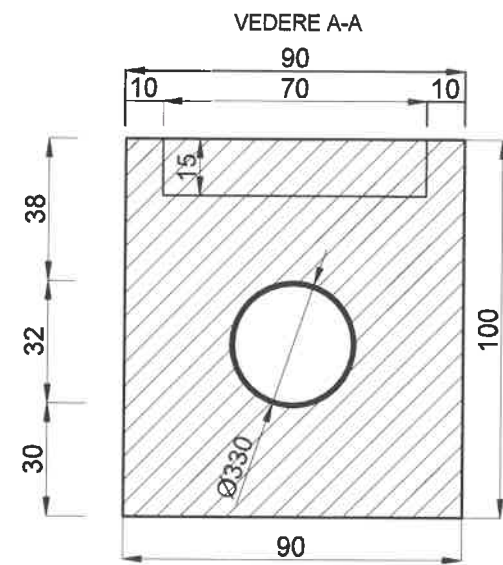
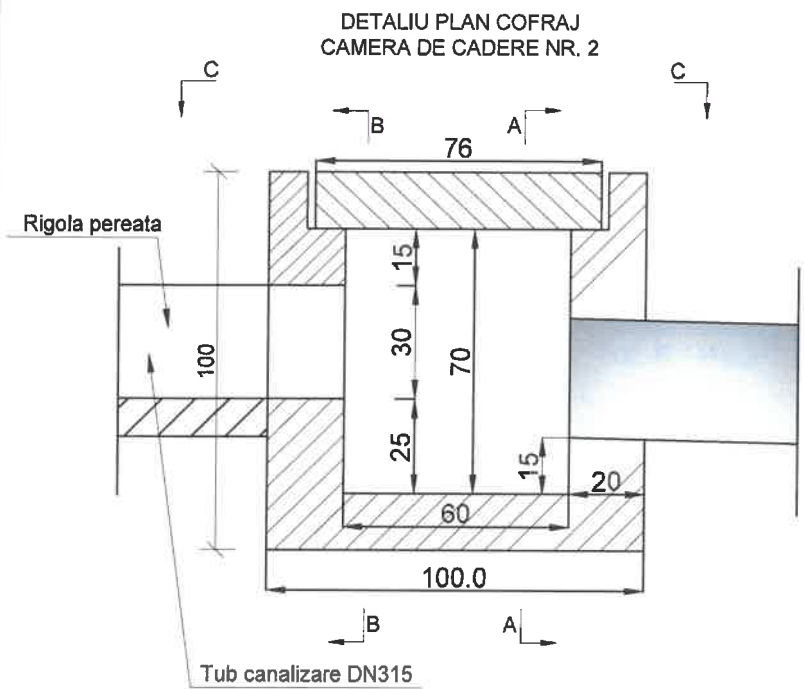

Plasa sudata Ø8mm,
ochiuri 100x100 mm

Plasa sudata Ø8mm,
ochiuri 100x100 mm

Plasa sudata Ø8mm,
ochiuri 100x100 mm

Plasa sudata Ø8mm,
ochiuri 100x100 mm

Plasa sudata Ø8mm,
ochiuri 100x100 mm

SUPRAFATA PLASA SUDATA OTEL Ø8mm, ochiuri 100x100 mm = 6,80 mp

BETON C25/30: 0.70 mc

BETON	C25/30
- CLASA DE EXPUNERE	= XC4
- GRAD DE IMPERMEABILITATE (min.)	= P4
- TIP CIMENT	= I A 52.5
- RAPORT APA/CIMENT (max.)	= 0.5

Verificator	Nume	Semnatura	Cerinta	Referat nr./data
Proiectant:	1ENGINEERING			Beneficiar:
1ENGINEERING SRL • RO28725629 • J13/1567/2011 • CONSTANTA, B-DUL TOMIS, NR. 143A				COMUNA LIMANU, JUDEȚUL CONSTANȚA
Scara: 1:50				ASIGURAREA INFRASTRUCTURII PENTRU TRANSPORT VERDE - PISTA DE BICICLETE IN COMUNA LIMANU, JUDEȚUL CONSTANTA
Sef proiect	ing.Sorin PANA	<i>[Signature]</i>	Data	Proiect nr. 241/2024
Proiectat	ing.Andreea ANTOHI	<i>[Signature]</i>	APRILIE 2024	Faza: P.T.+D.E.
Verificat	ing.Sorin PANA	<i>[Signature]</i>		Plansa nr. C.02